

4b
OX

 finder®

2024
catalogue



FOR AN INNOVATIVE
AND PRACTICAL
ELECTRICAL INSTALLATION

*Patented power sockets, USB power supplies,
smart controls, and much more*



2024
catalogue

4box

offers a wide range of modern solutions that revolutionize the world of **electrical switches and sockets**.

User-friendly and innovative, making installation an **easy, fast and safe**. **Side, P503 and USBP40** are patented devices that demonstrate a true evolution.

4box also boasts products such as **Wide, Uniko** and the **20 W Power Delivery USB** power supplies.

4box – Now part of the Finder Group

Finder and 4box share a culture based on the **quest for simple and original solutions** that provide added value for the customer.

The merger of these two entities aids the development and distribution of **new products and technologies**, offering excellent customer support.





Contents

P SERIES p.06



4b Side

p.08



4b Side XL

p.14



4b P40

p.16



4b P503

p.20



4b Bitappo

p.24

C SERIES p.28



4b Uniko

p.30

U SERIES p.38



4b USB 2.1

p.40



4b USB 2.4

p.40



4b USB CA 20W

p.44

NEW



4b USB CCA 20W

p.48



4b USBP40 3.0

p.52



4b USBP503

p.56

B SERIES p.60



4b Libero

p.62



4b Cover Plates

p.66



4b Bundle

p.70



4b Hide

p.72



4b Titappo

p.76

E SERIES p.78



4b Wide

p.80



4b Externa IP40

p.86



4b Externa IP55

p.86

S SERIES p.88



4b P40 S

p.92



4b UnikoLite S

p.96



4b UnikoPro S

p.100



4b RelayLite S

p.104



4b RelayPro S

p.104



P SERIES

The **P SERIES** is **compatible** with Bticino®, Vimar® and Gewiss® product ranges. 4box's strict safety and quality standards ensure the highest level of product reliability and durability for both installer and end user.

P SERIES. Patented and innovative electrical sockets.



4b Side



4b Side XL



4b P40

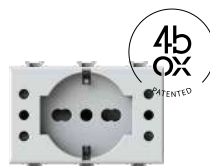

4b P503



4b Bitappo



4b Side

Thanks to Side, you can eliminate the need for adaptors. With just two modules, you can now enjoy the functionality of two types of socket. You can use either one Schuko socket, or two bipasso sockets. Side is compatible with the most popular residential and commercial electrical wiring systems.



Three times one equals one!

The module includes one Schuko socket or two bipasso sockets. It's a new and innovative multi-socket concept that eliminates the need for adaptors.

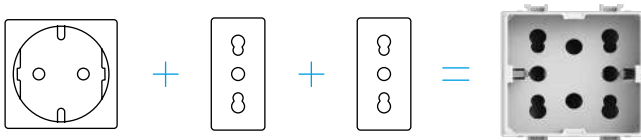

Compatible with the most popular residential and commercial wiring accessory systems

Bticino®
Matix™, Matix Magic™, LivingLight™,
Idrobox™ enclosures

Vimar®
Plana™, Arkè™, Eikon™, Isozet™ enclosures

Gewiss®
System™, Chorus™, Combi™ enclosures

Designed and patented in Italy, Side is one of a number of 4box products that are unique in their field.

Schuko, bipasso, or Side!



Highlights

- 

Three sockets in one,
one Schuko or two bipasso
- 

Compatible with the most
popular residential and commercial
wiring accessory systems
- 

No need for
adaptors
- 

**Competitively
priced**
- 

A single terminal block for
quick and easy installation
- 

Side is a **patented
product**



Focused **creativity**

Side is one of 4box's most significant innovations. The concept is really simple, but the result is amazing: **three different types of electrical outlets in a single module.**

The **4** features of Side



1. No more adaptors

With Side you can connect devices fitted with Schuko plugs without the need for adaptors.



2. Saves space

With Side you can use two 10 A or 16 A plugs at the same time in a single module.



3. Versatile

With Side you can use Italian Standard (2P 10 A, 2P+E 10 A, 2P+E 16 A) and German Standard (2P+E) plugs.



4. Easy to install

Side is fitted with a single terminal block, which makes installation quicker and easier.

4b Side | FOR EXTERNA* IP40 AND IP55

Side is also available in Externa IP40 and IP55 versions to provide greater functionality and versatility in environments where such equipment is required by regulations. Side eliminates the need for adaptors to connect vacuum cleaners, pressure washers, lawnmowers, compressors or household appliances. Maximum safety and compliance with regulations all in one socket.

**You can find Externa IP40 and IP55 on page 86*



4b Side | FOR PANELS

Side is the socket that does not require a mounting frame to install the socket outlet.

Ideal for workstations, office furniture, rack panels and railway rolling stock.

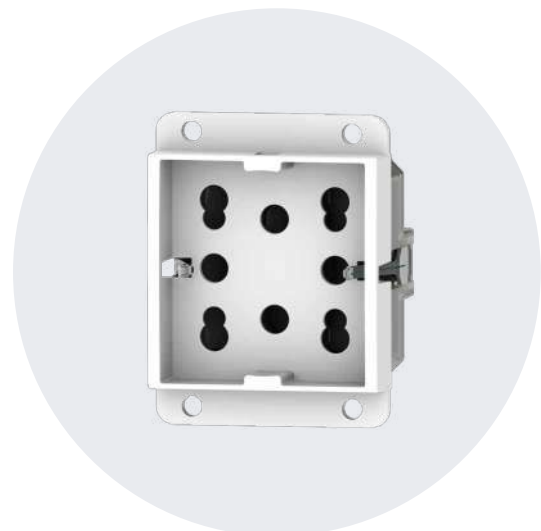

4b Side | FOR HIDE*

Innovate to the maximum with 4box. Side can also be used together with Hide – another 4box innovation.

**You can find Hide on page 72*



Catalogue



Side is compatible with the most popular residential and commercial wiring accessory systems. See below for cross-reference chart and part numbers.

Plugs suitable for use with Side

Italian standard

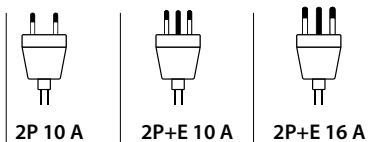

German standard

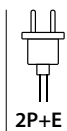

Side – compatible with Bticino®



4B.AM.H21
Side for
Matix™
White



4B.AMR.H21
Side for
Matix™
Red



4B.A.H21
Side for
Matix Magic™
Ivory



4B.N.H21
Side for
LivingLight™
White



4B.L.H21
Side for
LivingLight™
Anthracite



4B.NT.H21
Side for
LivingLight™
Tech



4B.LR.H21
Side for
LivingLight™
Red

Side – compatible with Vimar®

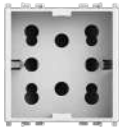

4B.V14.H21
Side for
Plana™
White

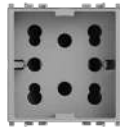

4B.V14SL.H21
Side for
Plana™
Silver



4B.V14R.H21
Side for
Plana™
Red



4B.V19B.H21
Side for
Arkè™
White



4B.V19.H21
Side for
Arkè™
Grey



4B.V19R.H21
Side for
Arkè™
Red



4B.V19M.H21
Side for
Arkè™
Metal



4B.V20B.H21
Side for
Eikon™
White



4B.V20.H21
Side for
Eikon™
Grey



4B.V20N.H21
Side for
Eikon™
Next



4B.V20R.H21
Side for
Eikon™
Red

Side – compatible with Gewiss®



4B.G20.H21
Side for
System™
White



4B.G20R.H21
Side for
System™
Red



4B.G10.H21
Side for
Chorus™
White



4B.G12.H21
Side for
Chorus™
Black



4B.G14.H21
Side for
Chorus™
Titanium

Side for panels



4B.SP.BN
Side for
panels
White



4B.SP.AN
Side for
panels
Anthracite

4b Side XL

The designers of Side have created a unique, revolutionary socket: Side XL.

This new electrical outlet is practical, convenient, compatible with the most popular residential and commercial wiring accessory systems, and competitively priced.

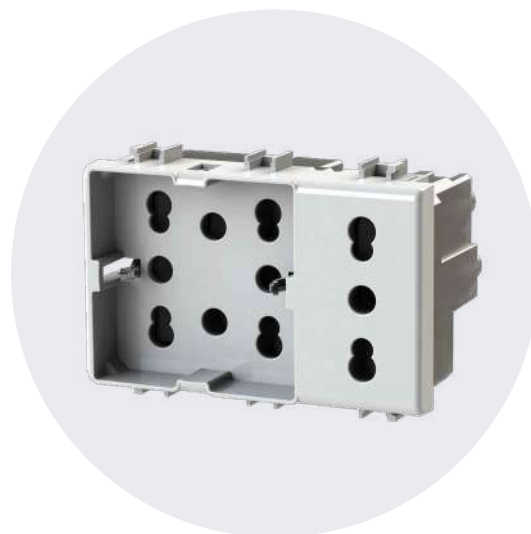

Four sockets in one

One Schuko and one bipasso or three bipasso sockets in just three modules. You can also use a bipasso and a Schuko socket simultaneously.

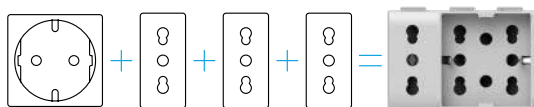

Compatible with the most popular residential and commercial wiring accessory systems

Bticino®
Matix™, LivingLight™

Vimar®
Plana™



Highlights

- 4

Four sockets in one, one Schuko and one bipasso or three bipasso sockets
- €

Competitively priced
- ⊗

Compatible with the most popular residential and commercial wiring accessory systems
- Ⓜ

Side XL is **patented**
- ✕

No need for **adaptors**

Catalogue

Side XL – compatible with Bticino®



4B.AM.H21.XL
Side XL for
Matix™
White



4B.N.H21.XL
Side XL for
LivingLight™
White



4B.L.H21.XL
Side XL for
LivingLight™
Anthracite



4B.NT.H21.XL
Side XL for
LivingLight™
Tech

Side XL compatible with Vimar®



4B.V14.H21.XL
Side XL for
Plana™
White

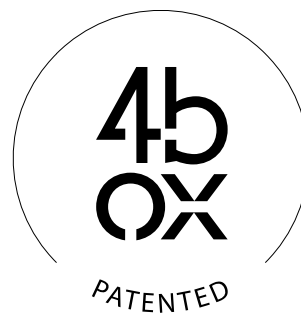

Plugs suitable for use with Side XL

Italian standard

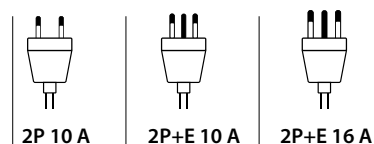

German standard

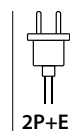

4b P40

The new universal standard socket from 4box. P40 gives you the functionality of the two most commonly used electrical sockets in a single module: a Schuko socket or a bipasso socket. P40 is available for the most popular residential and commercial wiring accessory systems.



Compatible with the most popular residential and commercial wiring accessory systems

Bticino®
Matix™, LivingLight™

Vimar®
Plana™, Arkè™

Gewiss®
System™

Compatible

P40 perfectly matches the look of the most popular residential and commercial wiring accessory systems, providing a viable alternative to more traditional sockets on the market.

Innovative

The innovative built-in wire **Stripper** allows you to **strip** 1.5 mm² and 2.5 mm² diameter wires without tools.

Flexible

A solution that allows you to create an electrical system that is **flexible** and **better suited to your needs**.

Highlights



No need for
adaptors

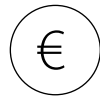

Competitively
priced



Compatible with the most
popular residential and commercial
wiring accessory systems

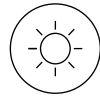

Option of making P40
an illuminated device



No more tools!
Built-in wires



Catalogue

The new 4box universal socket

4box has expanded its range with the new universal socket. The new socket outlet is practical, convenient and compatible with the most popular residential and commercial electrical wiring systems. It is also competitively priced.

Plugs suitable for use with P40

Italian standard

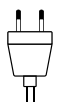

2P 10 A

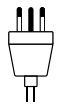

2P+E 10 A



2P+E 16 A

German standard

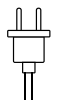

2P+E

P40 – compatible with Bticino®



4B.AM.P40
P40 for
Matix™
White



4B.AMR.P40
P40 for
Matix™
Red



4B.N.P40
P40 for
LivingLight™
White



4B.NT.P40
P40 for
LivingLight™
Tech



4B.L.P40
P40 for
LivingLight™
Anthracite



4B.LR.P40
P40 for
LivingLight™
Red

P40 – compatible with Vimar®



4B.V14.P40
P40 for
Plana™
White



4B.V14R.P40
P40 for
Plana™
Red



4B.V19.P40
P40 for
Arké™
Grey



4B.V19B.P40
P40 for
Arké™
White



4B.V19M.P40
P40 for
Arké™
Metal

P40 – compatible with Gewiss®



4B.G20.P40
P40 for
System™
White



4B.G20R.P40
P40 for
System™
Red

4b P503

P503 offers the best possible performance whilst allowing you to optimize the available space.

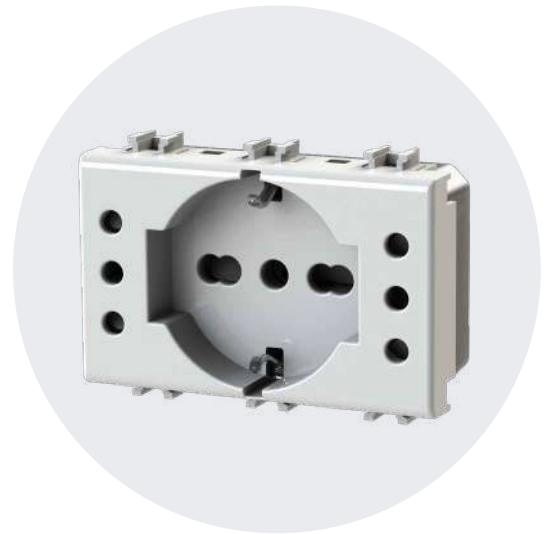

The new multi-socket standard in just 3 modules

The P503 is a flush-mounted socket that houses a universal Schuko socket, three 10 A sockets and one 10/16 A socket in just three modules. P503 is fitted with a **single power terminal block** for quick and easy installation.

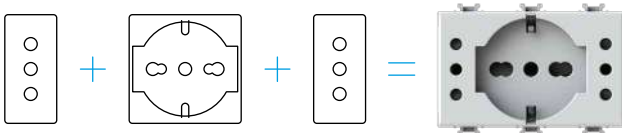

Compatible with the most popular residential and commercial wiring accessory systems

Bticino[®]
Matix[™], LivingLight[™], LivingNow[™]

Vimar[®]
Plana[™], Arkè[™]

Widely compatible

P503 is **compatible in finish and colour** to the Home range, making it a viable alternative to traditional sockets.

Innovative

A **single power terminal block** makes installation quicker and requires no masonry work. **The new standard in just 3 modules.**

Flexible

A **flexible solution** that allows you to create the perfect system for your requirements.



Highlights

- 5 **Five sockets in one**, one Schuko, 3 10 A sockets and one 10/16 A socket
- € **Competitively priced**
- ⊖ **Compatible** with the most popular residential and commercial wiring accessory systems
- ⚡ **A single terminal block** for quick and easy installation
- ✗ **No need for adaptors**
- ® **P503 is a patented product**



Is it magic?

No, just innovation

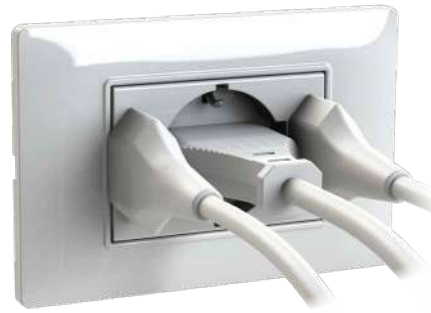

1. No more adaptors

With P503, you can connect devices fitted with Schuko plugs without the need for adaptors.

2. Saves space

With P503, you can use three plugs at the same time in a single three-module outlet.

A single power supply terminal

P503 is fitted with a **single terminal block** for quick and easy installation.

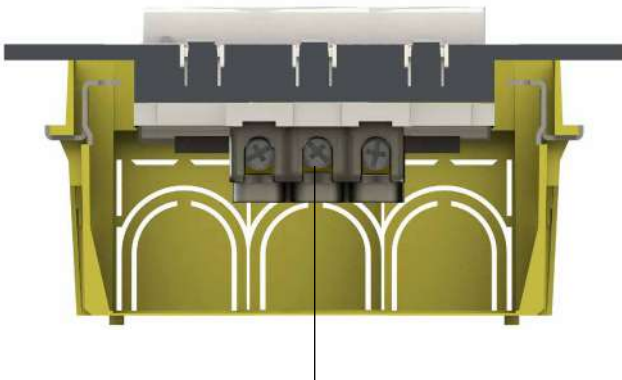

- A **single power supply terminal block** makes **wiring quick and easy**.
- The space available for **cable routing** from the bottom is between **1.7 cm and 2 cm** depending on the box model.

Did you know that...

10 A plugs are used for:

- *PC Monitors*
- *Laptops*
- *Hair straighteners*
- *Dehumidifiers*
- *Electric toothbrushes*
- *Soundbar speakers*
- *Televisions*
- *Stereo hi-fi systems*
- *Fans*
- *Air fryers*
- *Blenders and juicers*
- *Gaming consoles*
- *Voice assistants*
- *Cordless vacuum cleaners*

Anything else?

No problem, P40 will probably do the job.

Catalogue

P503 – compatible with Bticino®



4BP503.AM
P503 for
Matix™
White

P503 – compatible with Vimar®



4BP503.V14
P503 for
Plana™
White



4BP503.L
P503 for
LivingLight™
Anthracite



4BP503.N
P503 for
LivingLight™
White



4BP503.NT
P503 for
LivingLight™
Tech



4BP503.V19
P503 for
Arkè™
Grey



4BP503.V19B
P503 for
Arkè™
White



4BP503.V19M
P503 for
Arkè™
Metal



4BP503.KG
P503 for
LivingNow™
Black



4BP503.KM
P503 for
LivingNow™
Sand



4BP503.KW
P503 for
LivingNow™
White

Plugs suitable for use with P503

Italian standard

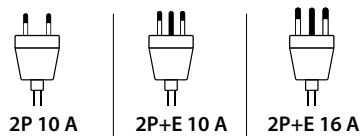

German standard

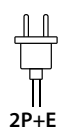

4b Bitappo

Bitappo is the innovative solution from 4box designed to simplify and speed up the installer's work. One 10/16 A socket and 2 blanking plates ready to be installed. If necessary, the blanking plates can be removed to create a different socket configuration.



A **ready-to-use**, simple and innovative **socket**.



Compatible with the most popular residential and commercial wiring accessory systems

Bticino[®]
Matix[™], LivingLight[™]

Vimar[®]
Plana[™], Arkè[™]

Gewiss[®]
System[™]

Faster

A 'ready to go' solution that reduces installation time.

Easier

A solution that **simplifies** project design and quotations.

Innovative

The innovative built-in wire **Stripper**, lets you strip 1.5 mm² and 2.5 mm² diameter wires without any tools.

Highlights



Just one product per socket outlet, one bipasso socket and two blanking plates



Competitively priced



Compatible with the most popular residential and commercial wiring accessory systems



Quick and easy to install



No more tools!
Built-in wire Stripper



Choose, snap off and install

Bitappo was designed to make your work **easier and faster**. The practicality you have been waiting for in a single, ready-to-use modular product that **you can take apart and reassemble at will** to create ever-changing solutions to customize your socket.



1. Choose



2. Snap off



3. Install

Stripper!

An ingenious solution

4box presents **Stripper**, a solution as simple as it is **ingenious** that allows you to **strip wires** of two different diameters, speeding up the installation process and eliminating the need for other tools.



1. Choose the diameter

Turn the blanking plate over and you will find two notches for stripping 1.5 mm² and 2.5 mm² diameter wires.



2. Insert the wire

Once you have selected the notch, insert the wire to be stripped.



3. Press and cut

Gently press and rotate the wire against the sharp edge of the notch to cut the insulation.



4. Pull the wire

Pull the wire outwards to strip the insulation.

Catalogue

Side – compatible with Bticino®



4B.AM.BT
Bitappo for
Matix™
White

Side – compatible with Vimar®



4B.V14.BT
Bitappo for
Plana™
White



4B.N.BT
Bitappo for
LivingLight™
White



4B.L.BT
Bitappo for
LivingLight™
Anthracite



4B.NT.BT
Bitappo for
LivingLight™
Tech



4B.V19B.BT
Bitappo for
Arkè™
White



4B.V19.BT
Bitappo for
Arkè™
Grey



4B.V19M.BT
Bitappo for
Arkè™
Metal

Side – compatible with Gewiss®



4B.G20.BT
Bitappo for
System™
White

Plugs compatible with Bitappo

Italian standard

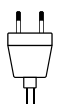

2P 10 A

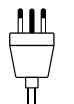

2P+E 10 A

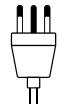

2P+E 16 A



C SERIES

Simplifying the installation process is one of 4box's main objectives.

Uniko is a multifunction-switch compatible with the main residential and commercial wiring accessory systems from Bticino®, Vimar® and Gewiss®. It provides for five functions to be implemented in a single device, depending on how the terminals are configured.

One-way switch, two-way switch, intermediate switch and NO/NC push-button in one control for maximum flexibility and speed of installation.

C SERIES. Multiple advantages in a single code.



4box Uniko



4b Uniko

Uniko has 5 functions.

One-way switch, two-way switch, intermediate switch and NO or NC push button, depending on how the terminals are configured.

Uniko from 4box is compatible with the main residential and commercial wiring accessory systems.

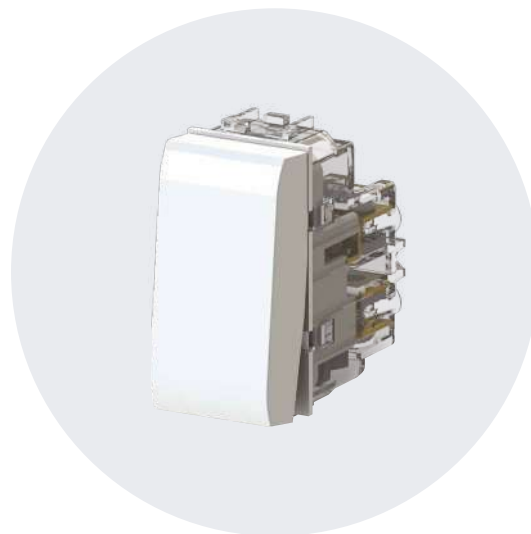

Compatible with the most popular residential and commercial wiring accessory systems

Bticino[®]
Matix[™], LivingLight[™]

Vimar[®]
Plana[™], Arkè[™], Eikon[™]

Gewiss[®]
System[™], Chorus[™]

Convenient

You decide how to use Uniko.

If you need to replace a faulty switch, you always have what you need.

Cost-effective



It is also competitively priced.

Uniko offers its many solutions at a **competitive price** compared to traditional switches.

Widely compatible

Uniko is **compatible in finish and colour** to the residential and commercial wiring accessory systems, making it a viable alternative to traditional switches.

Highlights

- 5 **Five in one:** one-way switch, two-way switch, intermediate switch and NO/NC push-button
-  **No need to change** function
-  **Compatible** with the most popular residential and commercial wiring accessory systems

- € **Competitively priced**
-  Option of making **Uniko** an illuminated device
- ® **Uniko is patented**



From a push-button to a rocker switch in just one simple step

An innovative mechanism for engaging and disengaging the spring inside the switch, using a standard Phillips or slotted screwdriver, lets you use **Uniko** as a rocker switch or as a push-button. **Easy, quick and safe!**



1. Choose

Decide whether to use Uniko as a one-way switch, two-way switch, intermediate switch or a NO/NC push-button*.

**If you change your mind,
Uniko is easy to reconfigure.**

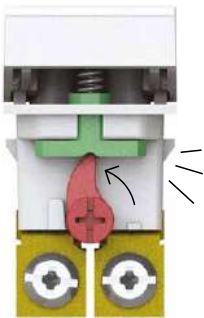

2. Change

Use a screwdriver to rotate the lever **upwards** to use Uniko as a push-button. Rotate the lever **downwards** to use Uniko as a rocker switch.



Five controls in one. Select, connect, done!

The way the switch works can be determined by how it is wired.

Each switch is supplied with an instruction sheet that explains in a simple and intuitive way how to make the connections to obtain a one-way switch, push-button, two-way switch or intermediate switch.

**In electrical systems, there are two types of button:*

- *Normally open (NO): as soon as it is pressed, it closes the circuit.*
- *Normally closed (NC): as soon as it is pressed, it opens the circuit.*

1. One-way switch

A one-way switch can be used to control the switching of lamps or other appliances from a single point in the house.



2. Two-way switch

A two-way switch can be used to switch lights or other appliances on or off from 2 or more different points. To connect 2 different light switches to control the same light, 2 two-way switches must be used.



3. Intermediate switch

An intermediate switch can be used to switch lights or other appliances on or off from 3 or more different points. By using an intermediate switch together with 2 two-way switches, you can switch from 3 separate points.

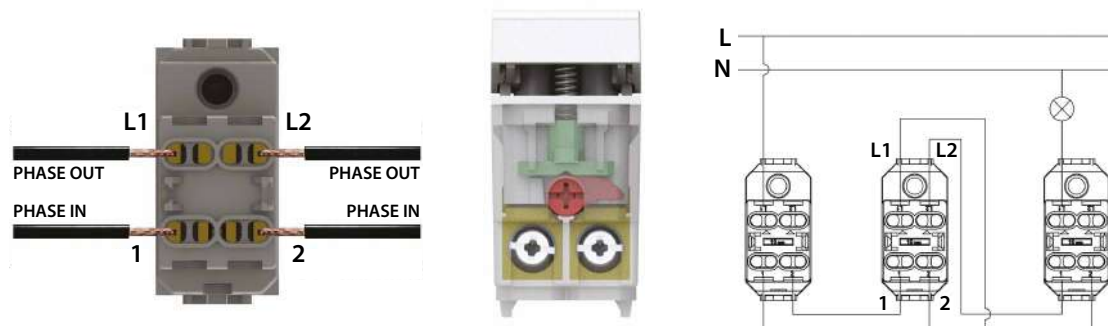

4. Push-button

A push-button is normally used in relay circuits. The push-button is fitted with a spring mechanism, which when pressed, sends an impulse to the coil, which switches lights or other appliances on or off. Push-buttons can be used to control the load from several separate points.

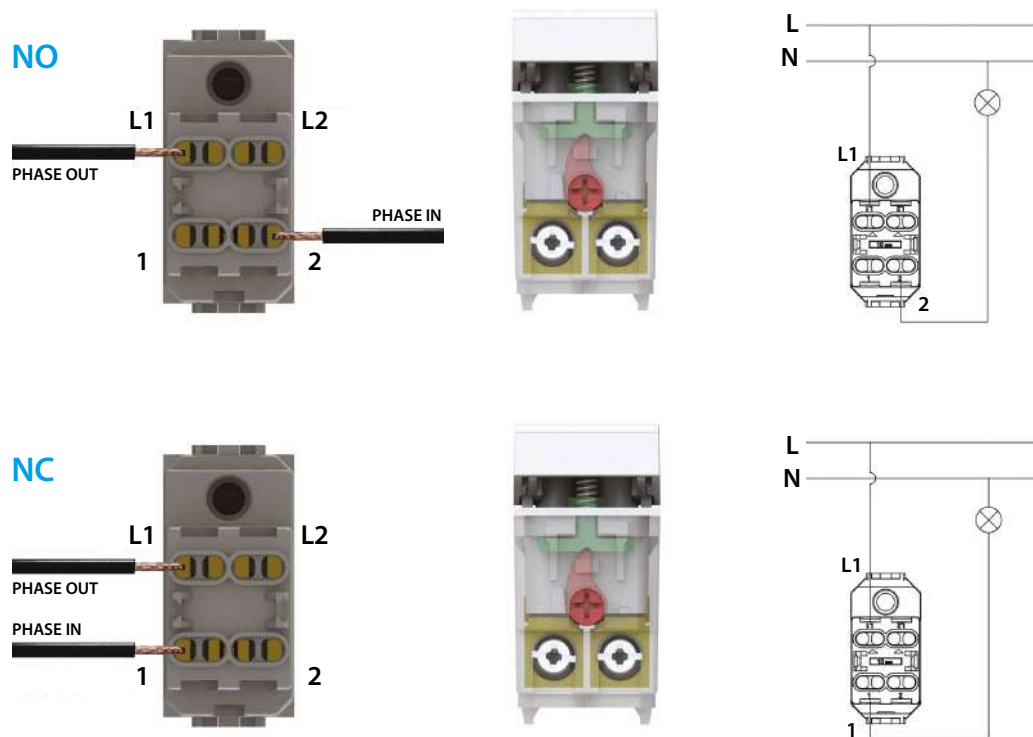

Catalogue

More benefits
in a single code



Uniko applications

- One-way switch*
- Two-way switch*
- Intermediate switch*
- NO/NC push button*

Uniko – compatible with Bticino®



4B.AM.CU
Uniko for
Matix™
White



4B.N.CU
Uniko for
LivingLight™
White



4B.L.CU
Uniko for
LivingLight™
Anthracite



4B.NT.CU
Uniko for
LivingLight™
Tech

Uniko – compatible with Vimar®



4B.V14.CU
Uniko for
Plana™
White

Uniko – compatible with Gewiss®



4B.G20.CU
Uniko for
System™
White



4B.V19B.CU
Uniko for
Arkè™
White



4B.V19.CU
Uniko for
Arkè™
Grey



4B.V19M.CU
Uniko for
Arkè™
Metal



U SERIES

Electrical systems are **evolving** due to the use of flush-mounted USB power supplies for residential and commercial wiring accessory systems. 4box, with the widest range of products on the market, offers its customers a variety of solutions.

U SERIES products ensure maximum charging speed in the smallest possible space, eliminating the need for external power supplies.

Perfectly matched looks and functional **compatibility** with the main residential and commercial wiring accessory systems from Bticino®, Vimar® and Gewiss®, and designed according to the latest technological standards to ensure that all devices are correctly powered and charged in the shortest possible time.

U SERIES. Good looks and maximum charging speed for your devices.



4b USB 2.1 2.4



4b USB CA 20W



4b USB CCA 20W



4b USBP40 3.0



4b USBP503



4b USB 2.1 2.4

Change the way you think about electrical sockets. USB 2.1 and 2.4 are the 4box single-module USB sockets with maximum output loads of 2.1 and 2.4 A respectively. Ideal for the for fast charging of smartphones, tablets and other devices, without having to use power supplies.



The fastest and most powerful range of USB power supplies in a single module

Maximum power, perfectly matched looks and minimum space requirements are the winning features of these products, whose quality has been certified by IMQ laboratories and awarded the relevant mark.



Compatible with the most popular residential and commercial wiring accessory systems

Bticino®
Matix™, LivingLight™, Axolute™

Vimar®
Plana™, Arkè™

Gewiss®
Chorus™

Easier

Simplification: The device can be connected directly to the USB 2.1 and 2.4 sockets without the need for power supplies.

More options

Customizable: Create your own combinations thanks to the devices' modularity. Can be combined freely with a bipasso plug, Side module or a blanking plate.

Highlights



2.1 A and 2.4 A



Perfectly matched with the most popular residential and commercial wiring accessory systems



Charge your devices without using power supplies



Competitively priced



Fitted with a **USB type A** socket, or **2 additional USB type A** sockets in a **single module (USB 2.4)**



Small
Only 47 mm deep



Catalogue

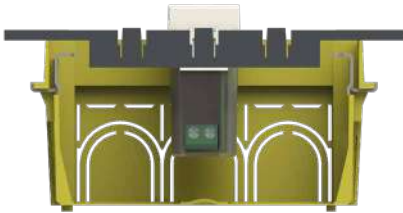

Small size, huge advantage

The small size of the USB socket means there is plenty of room for cable routing (1.2 cm to 1.5 cm from the bottom of the box depending on the model).

Compatible with

USB 2.1

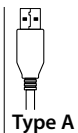

USB 2.4

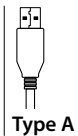

Compatible with Bticino®

4B USB 2.1



4B.AM.USB
USB 2.1 for
Matix™
White

4B USB 2.4



4B.AM.USB.24
USB 2.4 for
Matix™
White



4B.N.USB
USB 2.1 for
LivingLight™
White



4B.N.USB.24
USB 2.4 for
LivingLight™
White



4B.L.USB
USB 2.1 for
LivingLight™
Anthracite



4B.L.USB.24
USB 2.4 for
LivingLight™
Anthracite



4B.NT.USB
USB 2.1 for
LivingLight™
Tech



4B.NT.USB.24
USB 2.4 for
LivingLight™
Tech



4B.HD.USB
USB 2.1 for
Axolute™
White

Compatible with Gewiss®

4b USB 2.1



4B.G12.USB
USB 2.1 for
Chorus™
Black

4b USB 2.4



4B.G10.USB.24
USB 2.4 for
Chorus™
White

Compatible with Vimar®

4b USB 2.1



4B.V14.USB
USB 2.1 for
Plana™
White

4b USB 2.4



4B.V14.USB.24
USB 2.4 for
Plana™
White



4B.V19B.USB.24
USB 2.4 for
Arkè™
White



4B.V19.USB.24
USB 2.4 for
Arkè™
Grey



4B.V19M.USB.24
USB 2.4 for
Arkè™
Metal

4b USB CA 20W

4box has recently added new additions to its single-module USB range. USB CA 20W is a USB socket with a 20 W output that can rapidly charge your devices thanks to Fast Charge technology and Power Delivery protocol.



The new faster and more powerful USB power supplies

USB CA 20W is the module with a USB C Power Delivery and a USB A Fast Charge, that brings you safe, super-fast charging for your devices.



The quality of excellence

Maximum power, perfectly matched looks and minimum space requirements are the winning features of these products, whose quality has been certified by IMQ laboratories and awarded the relevant mark.



Compatible with the most popular residential and commercial wiring accessory systems

Bticino®
Matix™, LivingLight™, Axolute™, LivingNow™

Vimar®
Plana™, Arkè™

Gewiss®
Chorus™

Faster

Fast Charge is a technology that allows battery-powered devices to be charged with **more power** than the typical 5 W and 2 A of most USB standards. It allows the device's battery to be **recharged faster** by acting on a charger's amperage and voltage, so as to **increase the battery's absorption capacity**.

Safer

Power Delivery is a **charging protocol via USB C** that delivers **more power, faster and more safely** than standard chargers. With **Power Delivery** you can charge your device up to **70% faster** than with standard chargers.

Highlights



20 W. Fast charge technology with Power Delivery protocol



Perfectly matched with the most popular residential and commercial wiring accessory systems



Charge your devices **without using power supplies**



Competitively priced



Fitted with a **USB type A socket** and a **USB type C socket** in a **single module**



Small
Only 47 mm deep



Catalogue

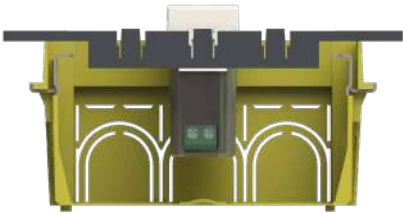

Small size, huge advantage

The small size of the USB CA socket means there is plenty of room for cable routing (1.2 cm to 1.5 cm from the bottom of the box depending on the model).

Compatible with

USB

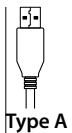

Type A

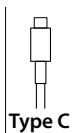

Type C

USB CA 20W – compatible with Bticino®



4B.AM.USB.30
USB CA 20W
for **Matix™**
White



4B.N.USB.30
USB CA 20W
for **LivingLight™**
White



4B.HD.USB.30
USB 3.0A
for **Axolute™**
White



4B.L.USB.30
USB CA 20W
for **LivingLight™**
Anthracite



4B.HS.USB.30
USB 3.0A
for **Axolute™**
Anthracite



4B.NT.USB.30
USB CA 20W
for **LivingLight™**
Tech



4B.HC.USB.30
USB 3.0A
for **Axolute™**
Tech



4B.K.USB.30
USB CA 20W
for **LivingNow™**
3 front plates supplied

USB CA 20W – compatible with Vimar®



4B.V14.USB.30
USB CA 20W
for **Plana™**
White



4B.V19B.USB.30
USB CA 20W
for **Arkè™**
White



4B.V19.USB.30
USB CA 20W
for **Arkè™**
Grey



4B.V19M.USB.30
USB 3.0A
for **Arkè™**
Metal

USB CA 20W – compatible with Gewiss®



4B.G10.USB.30
USB 3.0 A
for **Chorus™**
White



4B.G12.USB.30
USB 3.0 A
for **Chorus™**
Black

4b USB CCA 20W

The most complete solution for USB charging in a single module. The CCA 20W USB socket quickly charges devices, is versatile and provides maximum safety.



More inputs. Faster charging

USB CCA 20W boasts two USB C Power Delivery ports and one USB A Fast Charge port, providing maximum charging speed and application flexibility.



Certified quality

IMQ certification guarantees the quality of these devices.



Compatible with the most popular residential and commercial wiring accessory systems

Bticino®
Matix™, LivingLight™, LivingNow™

Vimar®
Plana™, Arké™, Linea™

Faster

Fast Charge is a technology that allows battery-powered devices to be charged with **more power** than the typical 5 W and 2 A of most USB standards. It allows the device's battery to be **recharged faster** by acting on a charger's amperage and voltage, so as to **increase the battery's absorption capacity**.

Safer

Power Delivery is a **charging protocol via USB C** that delivers **more power, faster and more safety** than standard chargers. With **Power Delivery** you can charge your device up to **70% faster** than with standard chargers.

Highlights



20 W. Fast charge technology with Power Delivery protocol



Perfectly matched with the most popular residential and commercial wiring accessory systems



Charge your devices **without using power supplies**



Competitively priced



Fitted with a **USB type A socket** and two **USB type C socket** in a single module



Small
Only 47 mm deep



Catalogue

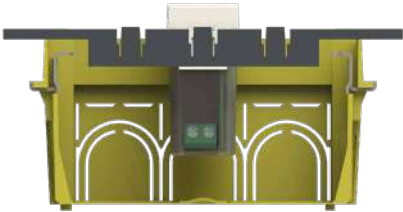

For almost **all your needs**. Locate it **wherever you wish**.

Easy and flexible installation thanks to the ample space available for cable routing.

Compatible with

USB

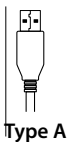

Type A

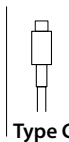

Type C

USB CCA 20W – compatible with Bticino®



4USB20WCCA.AM
USB CCA 20W
for **Matix™**
White



4USB20WCCA.N
USB CCA 20W
for **LivingLight™**
White



4USB20WCCA.L
USB CCA 20W
for **LivingLight™**
Anthracite



4USB20WCCA.NT
USB CCA 20W
for **LivingLight™**
Tech



4USB20WCCA.K
USB CCA 20W
for **LivingNow™**
3 front plates supplied

USB CCA 20W – compatible with Vimar®



4USB20WCCA.V14
USB CCA 20W
for **Plana™**
White



4USB20WCCA.V19B
USB CCA 20W
for **Arkè™**
White



4USB20WCCA.V19
USB CCA 20W
for **Arkè™**
Grey



4USB20WCCA.V30
USB CCA 20W
for **Linea™**
3 front plates supplied

4b USBP40 3.0

More than just a multifunctional socket. USBP40 3.0 is the socket that integrates a P40 and a 3 A USB type C power supply in just 2 modules. The new 4box electrical outlet ensures simultaneous use and fast charging.



P40 socket and **3 A USB** power supply integrated in just **2 modules**

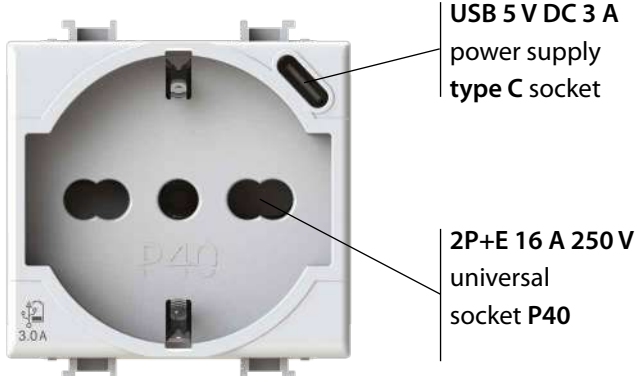

Compatible with the most popular residential and commercial wiring accessory systems

Bticino®
Matix™, LivingLight™, LivingNow™

Vimar®
Plana™, Arkè™

Faster

The USB power supply can deliver up to **3 A**, ensuring **maximum charging speed**. The **type C** outlet allows devices such as **laptops** to be powered and charged **without the use of power supplies**.

Modern

USBP40 3.0 powers both the traditional **type P40** socket and the **USB power supply** at the same time.

Widely compatible

USBP40 3.0 is **compatible** with the **leading residential and commercial wiring accessory systems** on the market, satisfying the tastes and choices of even the most demanding customers.

Highlights



Maximum power
and recharge speed



Fitted with a
3 A USB type C socket



Compatible with the most popular
residential and commercial wiring
accessory systems



USB40 3.0 is
patented



No need for **adaptors**
or **power supplies**



4box reinvents the concept of the electrical socket

4box has integrated a 3 A USB power supply into a P40 socket to meet the needs of modern electrical systems that satisfy even the most demanding customers. USBP40 3.0 is patented.

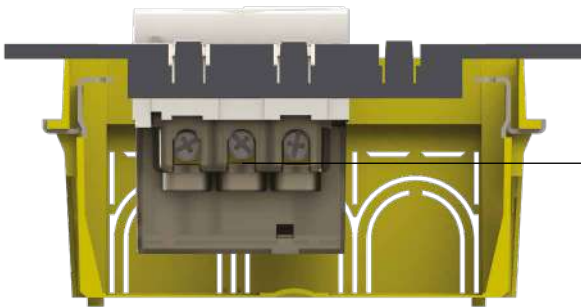

- A single power supply terminal makes wiring quick and easy
- The space available for cable routing from the bottom is between 0.7 cm and 1 cm depending on the model

For the installer:

USBP40 3.0 is a new selling point for installers, who have the opportunity to offer the customer a new solution to improve their electrical system.

For the distributor:

USBP40 3.0 gives distributors the opportunity to innovate their product range, offering a unique product to their customers.

For the end customer:

No more worries about charging! With USBP40 3.0, you always have the fastest, most powerful power supply available to power and charge all your devices.

Do you have a USB type A connector? No problem!

4box provides a free type C to type A adaptor with every socket. This means that those who do not yet have a type C connector on their device can use the built-in USB power supply straight away.



Catalogue

USBP40 3.0 – compatible with Bticino®



4B.AM.P40.USB
USBP40 3.0
for **Matix™**
White

USBP40 3.0 – compatible with Vimar®



4B.V14.P40.USB
USBP40 3.0
for **Plana™**
White



4B.N.P40.USB
USBP40 3.0
for **LivingLight™**
White



4B.L.P40.USB
USBP40 3.0
for **LivingLight™**
Anthracite



4B.NT.P40.USB
USBP40 3.0
for **LivingLight™**
Tech

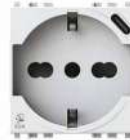

4B.V19B.P40.USB
USBP40 3.0
for **Arkè™**
White



4B.V19.P40.USB
USBP40 3.0
for **Arkè™**
Grey



4B.V19M.P40.USB
USBP40 3.0
for **Arkè™**
Metal



4B.KW.P40.USB
USBP40 3.0
for **LivingNow™**
White



4B.KG.P40.USB
USBP40 3.0
for **LivingNow™**
Anthracite



4B.KM.P40.USB
USBP40 3.0
for **LivingNow™**
Sand

Plugs compatible with USBP40 3.0

Italian standard

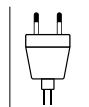

2P 10 A



2P+E 10 A



2P+E 16 A

German standard

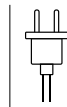

2P+E

USB

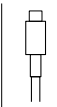

Type C

4b USBP503

USBP503 is the first universal recessed charging point. With 5 electrical sockets, 2 USB type C outputs and a single wiring terminal, it represents the ultimate in 4box-branded versatility and simplicity.

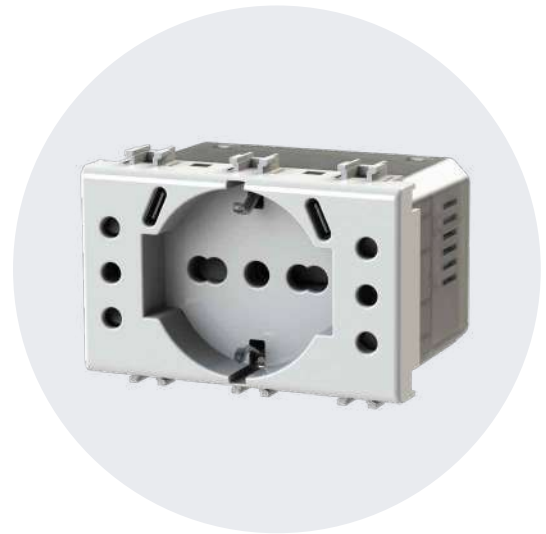

USBP503 lets you to use up to **5 sockets simultaneously** – in just **3 modules!**

USBP503 is the compact, flush-mounted multi-socket designed to optimize space. 5 different electrical sockets and 2 USB type C outputs in one device, that can be installed in a traditional 3-module 503 box.

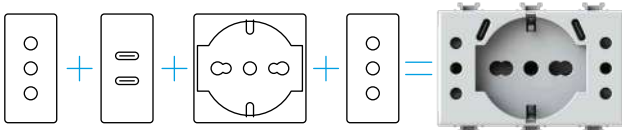

Compatible with the most popular residential and commercial wiring accessory systems

Bticino®
Matix™, LivingLight™, LivingNow™

Vimar®
Plana™, Arkè™

More versatile

5 different sockets to suit every need, so you can finally say goodbye to adaptors and power supplies.

Safer

With its internal temperature sensor and self-learning memory, the USBP503 prevents overheating of connected devices.

Universal

The first truly universal flush-mounted charging station.



Highlights



Maximum power
and recharge speed



Competitively
priced



Compatible with the most popular
residential and commercial wiring
accessory systems



Fitted with **two**
3 A USB type C socket



No need for **adaptors**
or **power supplies**



USBP503
is **patented**



The new standard in electrical sockets



1. No more adaptors

With USBP503, you can connect devices fitted with Schuko and USB type C connectors without the need for adaptors or power supplies.

2. Saves space

With USBP503, you can use five plugs at the same time in a single three-module socket.

A single power supply terminal

USBP503 is fitted with a **single terminal block** for quick and easy installation.

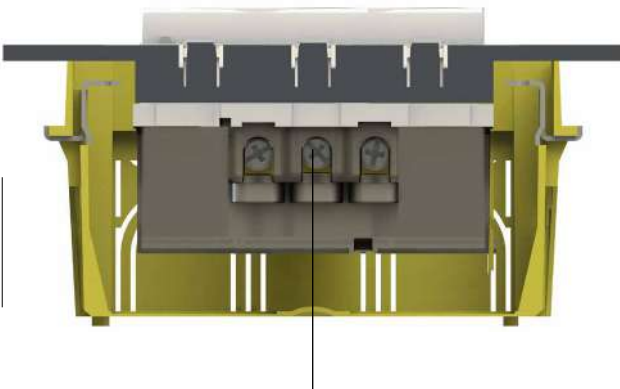

- A **single power terminal block** makes wiring **quick and easy**.
- The space available for **cable routing** from the bottom is between **1 cm and 1.3 cm** depending on the box model.

Did you know that...

In 2024, the USB C connector will become the new European standard for charging devices, establishing a single charging solution for electronic devices such as:

- Laptops
- Tablets
- Smartphones
- Smart watches
- True wireless headphones
- E-readers
- Digital cameras
- Portable gaming consoles
- Portable loudspeakers

In addition, the USB C standard is already present in many other electronic devices.

Catalogue

USBP503 – compatible with Bticino®



4BUSBP503.AM
USBP503 for
Matix™
White

USBP503 – compatible with Vimar®



4BUSBP503.V14
USBP503 for
Plana™
White



4BUSBP503.L
USBP503 for
LivingLight™
Anthracite



4BUSBP503.N
USBP503 for
LivingLight™
White



4BUSBP503.NT
USBP503 for
LivingLight™
Tech



4BUSBP503.V19
USBP503 for
Arkè™
Grey



4BUSBP503.V19B
USBP503 for
Arkè™
White



4BPUSB503.V19M
USBP503 for
Arkè™
Metal

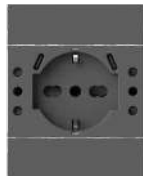

4BUSBP503.KG
USBP503 for
LivingNow™
Black



4BUSBP503.KM
USBP503 for
LivingNow™
Sand



4BUSBP503.KW
USBP503 for
LivingNow™
White

Plugs compatible with USBP503

Italian standard

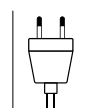

2P 10 A

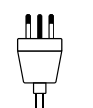

2P+E 10 A

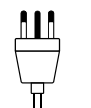

2P+E 16 A

German standard

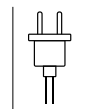

2P+E

USB

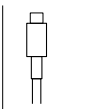

Type C



B SERIES

4box offers a number of complementary devices that are **essential** for creating an electrical system that can be used with various wiring accessory products around the home. These include socket frames and blanking plates – products that may be simple accessories, but ones for which 4box has nevertheless developed **innovations**.

Libero is the multi-series frame that revolutionizes the way in which wiring accessories are installed. You can choose finishes and cover plates from other Series and systems for a total customization of the look of your installation.

Titappo is the world's first and only blanking plate fitted with **Stripper**, an ingenious 4box patent that lets you strip the wires without tools.

B SERIES. Simple devices for a modern and innovative system.

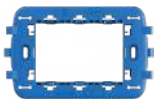

4b Libero



4b Cover Plates



4b Bundle



4b Hide



4b Titappo



4b Libero

Until now, for every wiring accessory system, there was only one frame on which the relative cover plates and modules could be installed.

With Libero, you can choose finishes from other ranges and other brands, allowing you the freedom to create a complete customization.

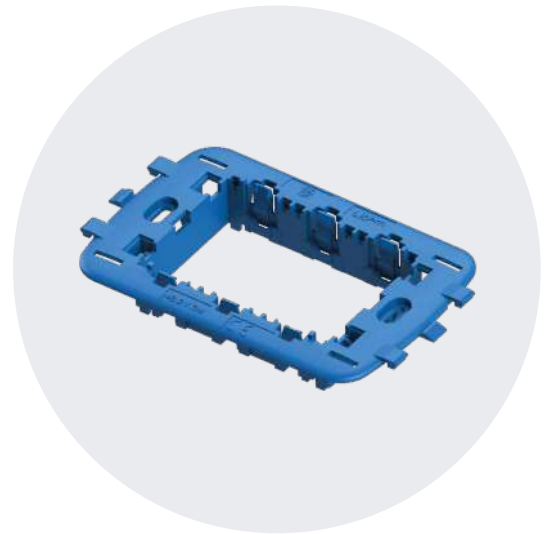

The **unique mounting frame** that **revolutionizes** the installation of the **most popular residential and commercial wiring accessory systems**

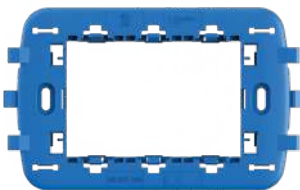

Compatible with the following systems:

Bticino®
LivingLight™

Vimar®
Eikon™, Arkè™, Plana™

Compatible with the following cover plates:

Bticino®
LivingLight™ quadra (not Air),
LivingInternational™, Axolute™ only 3 modules (not Air)

Vimar®
Plana™, Arkè™ (not Fit), Eikon™

Freedom for you

You can choose from the look and functions offered by the leading manufacturers of residential and commercial wiring accessory systems, **without having to use their frame.**

Versatile

With **Libero** you can **change the cover plate** of residential and commercial wiring accessory systems **without having to do invasive and expensive work.** Changing the look of your living space has never been **easier.**

Widely compatible

The **Libero** support is **compatible** with modules, functions and plates offered by manufacturers, allowing you to **combine quality and personal taste.**

Highlights

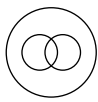

Compatible with the most popular residential and commercial wiring accessory systems



Competitively priced



An exceptionally wide **endless choice of 'look'**



For 2, 3, 4 or 7 module cover plates



A simple solution full of advantages

A unique and original mounting frame that lets you install the modules, functions and cover plates of the most popular residential and commercial wiring accessory systems. With Libero from 4box, **you are no longer limited by a lack of choice** or time constraints. Change the look of your home when you want and however you want.



Libero – two modules

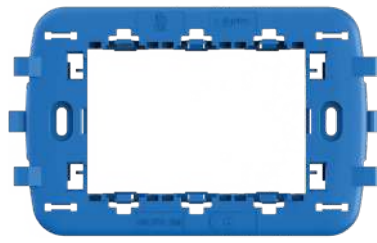

Libero – three modules



Libero – four modules



Libero – seven modules

For the installer:

The choice of frame **does not limit the final choice** of finish, optimizing work time and giving the customer more time to decide.

For the distributor:

Having a **single code** for different frames lets you optimize your inventory and market your products more **efficiently**.

For the end customer:

For the first time, you are free to **choose cover plates and modules from different manufacturers** to create your own original and customized solution.

All for one, one for all

Libero gives you the opportunity to **change the look** of your wiring accessories, and much more. By associating Libero with 4box devices, **thanks to their versatility and their compatibility** with the most popular residential and commercial wiring accessory systems, you can change the look of your living space simply and effectively.

Changing the look has never been easier.

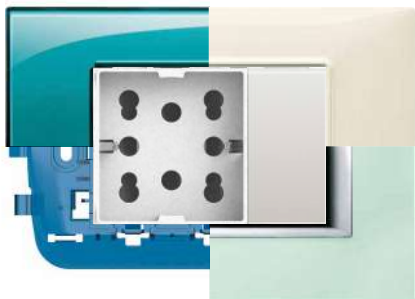

Use with Bticino® Living™ International cover plates

In order to use the Libero support with Bticino® Living™ International cover plates it is necessary to **remove the tabs** shown in the picture.

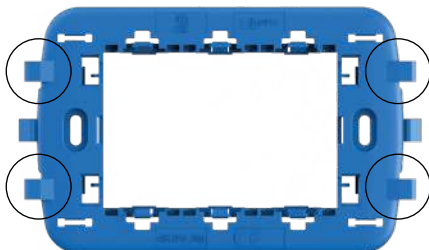

Catalogue



4B.BV.2M
Libero for
Bticino® and Vimar®
2 modules

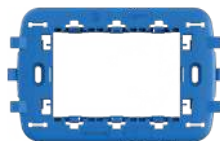

4B.BV.3M
Libero for
Bticino® and Vimar®
3 modules



4B.BV.4M
Libero for
Bticino® and Vimar®
4 modules



4B.BV.7M
Libero for
Bticino® and Vimar®
7 modules

4b Cover Plates

Interchangeable wiring accessory cover plates are an important decorative feature of your home. With their simple lines and neutral colours, these new additions look great in almost any setting, whether residential or commercial.



Having the option of using wiring accessories with **2, 3, 4 and 7 modules** widens your choice, and increases the number of **different functions** you can use for your application.

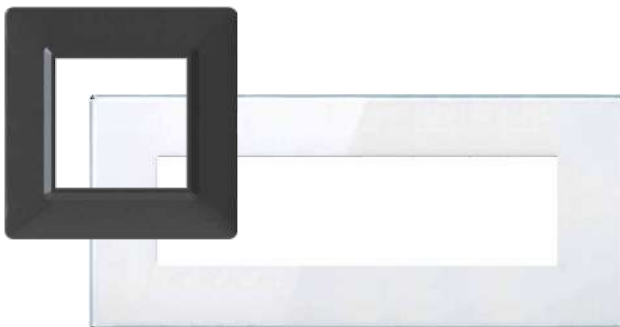

Compatible with the following frames:

4box
Libero

Bticino®
Matix™

Vimar®
Plana™, Arkè™, Eikon™

Widely compatible

Depending on the model, 4box top plates can be used with the most popular residential and commercial wiring accessory systems, including: Bticino® Matix™, Vimar® Plana™, Arkè™ and Eikon™, as well as with 4box's own Libero.

Cost-effective

By using technopolymer and methacrylate, these top plates are both cost-effective and 'affordable'.

Tough

Methacrylate itself is crystal clear. Being significantly lighter and much stronger, it is often used as an alternative to glass.

Highlights



Neutral look suitable for most living spaces



Competitively priced



Compatible with the most popular residential and commercial wiring accessory systems



Different materials, different look to suit almost any environment



Methacrylate and technopolymer for the best look

These two low-cost materials look fabulous. Methacrylate has an amazing glass-like effect, and technopolymer looks great in almost any setting.

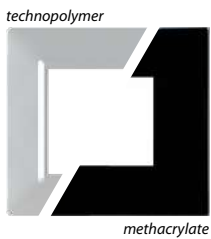

2 module cover plate

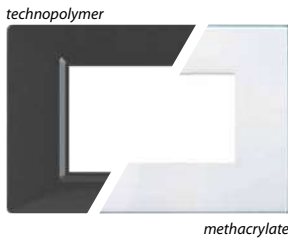

3 module cover plate

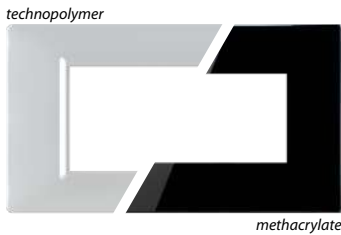

4 module cover plate

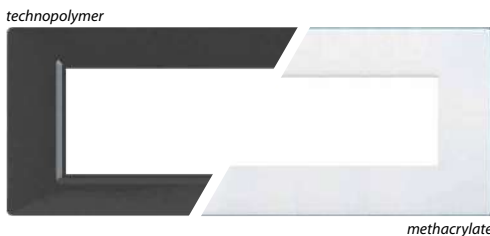

6-7 module cover plate

Catalogue

Cover plate – compatible with Bticino®

Methacrylate



4B.BG.2M.BN
2 module cover plate
for Matix™
White



4B.BG.2M.NR
2 module cover plate
for Matix™
Anthracite



4B.BG.3M.BN
3 module cover plate
for Matix™
White



4B.BG.3M.NR
3 module cover plate
for Matix™
Anthracite



4B.BG.4M.BN
4 module cover plate
for Matix™
White



4B.BG.4M.NR
4 module cover plate
for Matix™
Anthracite

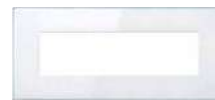

4B.BG.6M.BN
6 module cover plate
for Matix™
White



4B.BG.6M.NR
6 module cover plate
for Matix™
Anthracite

Cover plate – compatible with Vimar®

Methacrylate



4B.BV.2M.BN
2 module cover plate
for Plana™, Arkè™,
Eikon™ and 4box Libero
White



4B.BV.2M.NR
2 module cover plate
for Plana™, Arkè™,
Eikon™ and 4box Libero
Black



4B.BV.3M.BN
3 module cover plate
for Plana™, Arkè™,
Eikon™ and 4box Libero
White



4B.BV.3M.NR
3 module cover plate
for Plana™, Arkè™,
Eikon™ and 4box Libero
Black



4B.BV.4M.BN
4 module cover plate
for Plana™, Arkè™,
Eikon™ and 4box Libero
White



4B.BV.4M.NR
4 module cover plate
for Plana™, Arkè™,
Eikon™ and 4box Libero
Black

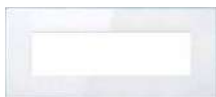

4B.BV.6M.BN
7 module cover plate
for Plana™, Arkè™,
Eikon™ and 4box Libero
White



4B.BV.6M.NR
7 module cover plate
for Plana™, Arkè™,
Eikon™ and 4box Libero
Black

Cover plate – compatible with Vimar®

Technopolymer



4B2MBN.V14
2 module cover plate
for Plana™
and 4box Libero
White



4B2MAN.V14
2 module cover plate
for Plana™
and 4box Libero
Black



4B3MBN.V14
3 module cover plate
for Plana™
and 4box Libero
White



4B3MAN.V14
3 module cover plate
for Plana™
and 4box Libero
Black



4B4MBN.V14
4 module cover plate
for Plana™
and 4box Libero
White



4B4MAN.V14
4 module cover plate
for Plana™
and 4box Libero
Black



4B7MBN.V14
7 module cover plate
for Plana™
and 4box Libero
White



4B7MAN.V14
7 module cover plate
for Plana™
and 4box Libero
Black

4b Bundle

4box offers a combination of different products to provide a complete, ready-to-use bundle. The new Cover Plate, combined with Libero frame and the multi-standard P503 and USBP503 sockets provide a good looking, functional solution.



Do you need to **add** or **replace** an electrical socket in your home?

4box Bundle is the answer!

The look of the products match almost all pre-existing installations, and the multi-standard P503 and USBP503 sockets, with their wealth of features, are the perfect combination.



Highlights



A ready-to-use solution



Competitively priced



A ready-to-use solution for **replacing or adding** an electrical socket



Single terminal for **quick and easy installation**

Catalogue



4BP503KIT.BN
Bundle with P503,
Libero frame and
Cover Plate – White



4BP503KIT.AN
Bundle with P503,
Libero frame and
Cover Plate – Anthracite



4BUSBP503KIT.BN
Bundle with USBP503,
Libero frame and
Cover Plate – White



4BUSBP503KIT.AN
Bundle with USBP503,
Libero frame and
Cover Plate – Anthracite

4b Hide

Hide revolutionizes the concept of the electrical socket. The plug disappears inside the wall, behind the sliding cover, leaving the wall neat and uncluttered.

Hide is very simple to use. Just slide the front panel, insert the plug and, that's it. You can camouflage Hide on your wall with a choice of different cover materials.

Can be installed within existing back boxes

Hide can be installed just like a conventional socket. Installation can be in 3- or 4-module flush-mounted boxes without the need for adaptors. There are no special wiring requirements.



Simply brilliant

Hide does not just mean style. It also means **functionality and ease of installation**. When designing the socket outlet that **revolutionized the electrical market**, 4box also thought about ease of installation. Hide is **compatible with existing boxes and wiring**. Hide never ceases to amaze: **an idea of the present, projected into the future.**

The intuition that makes the difference

Hide is the result of a collaboration between 4box and Italy Innovazioni.



Highlights



A wide range available,
according to **your needs**



Child safe
with sliding door closure



Customizable, from finishes
available on the market, to DIY



Protrudes **only 11 mm** from
the wall with the plug inserted



Installation in **3- or 4-module**
flush-mounted boxes





Attractive

Minimal: A fine, linear design that reflects an evolved, innovative and personal approach.

Evolved: Turns an electrical outlet into a **original accessory** that helps to keep things tidy.



Functional

Frees up space: It allows you to **position furniture close to sockets** without the annoyance of a plug.

Compact: It protrudes **only 11 mm** from the wall when the plug is inserted, ensuring a **low visual impact**. Cable clutter is no longer an issue.



Customizable

Customizable: Hide can be painted or **decorated** with wall coverings, wallpaper or screen prints. **You can let your imagination run wild.**

Multi-material: the ABS plastic door can be **clad** in glass, wood, metal, marble and other materials of your choice for **maximum freedom of design**.



Safe

Protected: No visible plugs mean **greater safety** for children.

Intuitive: **Extremely easy** to install and use.

Would you like to use your own sockets?

If so, you can order frame-only versions of Hide, which you can use with the Vimar® Plana™ Series sockets.

Sockets with French, German, Swiss, U.S., Israeli, Argentine and Euro-American standards are also available upon request.

Catalogue

Hide – 3 and 4 modules



4B.01.000
Frame only
3 modules
White

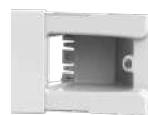

4B.04.000
Frame only
4 modules
White



4B.01.014
2 bipasso sockets
3 modules
White



4B.04.014
2 bipasso sockets
4 modules
White



4B.01.015
Schuko and
bipasso sockets
3 modules
White



4B.01.H21
Side
3 modules
White



4B.04.H21
Side
4 modules
White



4B.03.000
Frame only
3 modules
Anthracite



4B.06.000
Frame only
4 modules
Anthracite



4B.06.015
Schuko and
bipasso sockets
4 modules
Anthracite



4B.03.H21
Side
3 modules
Anthracite

Hide was designed by Italy Innovazioni.

4b Titappo

Titappo is the world's only blanking plate supplied with Stripper. This innovative technology allows you to strip wires of two different diameters (1.5 mm² and 2.5 mm²) without tools. With Titappo, your installation is ready to go.

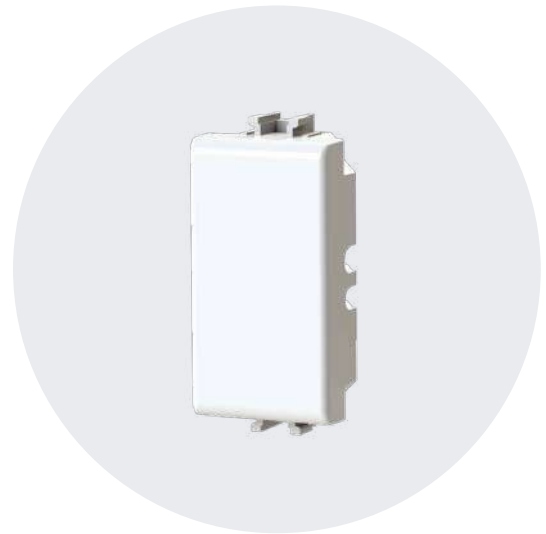

The first blanking plate with built-in wire Stripper

With Titappo and Stripper, a fantastic new 4box patent, your installation is ready to go.



Compatible with the most popular residential and commercial wiring accessory systems

Bticino[®]
Matix[™], LivingLight[™]

Vimar[®]
Plana[™], Arkè[™]

Gewiss[®]
System[™]

Catalogue

Titappo – compatible with Bticino[®]



4B.AM.TT
Titappo for
Matix[™]
White



4B.N.TT
Titappo for
LivingLight[™]
White



4B.L.TT
Titappo for
LivingLight[™]
Anthracite



4B.NT.TT
Titappo for
LivingLight[™]
Tech

Highlights



Compatible with the most popular residential and commercial wiring accessory systems



Competitively priced



No more tools!
Built-in wire stripper



Quick and easy
to install

Titappo – compatible with Vimar®



4B.V14.TT
Titappo for
Plana™
White



4B.V19B.TT
Titappo for
Arkè™
White



4B.V19.TT
Titappo for
Arkè™
Grey



4B.V19M.TT
Titappo for
Arkè™
Metal

Titappo – compatible with Gewiss®



4B.G20.TT
Titappo for
System™
White



E SERIES

With 4box, your electrical system can be enhanced with **unique solutions** that increase efficiency and practicality by making certain everyday tasks, such as inserting an electrical plug into a socket or switching on a light, simpler and more functional. Whether indoors or outdoors, 4box's **E SERIES** products meet the needs of everyday life by adding value to your electrical system.

E SERIES. Simple ideas that enhance your home.



4b Wide



4b Externa IP40



4b Externa IP55



4b Wide

Wide is the only enclosure in the world that retains its IP55 protection rating even with the plug connected when installed in its 3-module flush-mounted box. What's more, it retains IP66 protection when mounted in its wall-mounted enclosure.

Wide takes the ingenious idea of Hide and adds a protection system against contact with solids and liquids. No other solution in the world can match this performance.



Advanced safety



Protection rating

IP55

With flush-mounted box

IP66

With wall-mounted enclosure

Compatible with the following residential and commercial wiring accessory systems:

Vimar®

Plana™ (in the Wide frame only version)

Waterproof

Its unique support, means that **Wide is waterproof even with the plug connected**, maintaining its IP55 or IP66 rating.

Attractive

Wide's elegant design means that it can be **installed in both residential settings**, such as balconies and gardens, and in tertiary/industrial settings.

Complete

With Wide, you can use the most common types of plugs available on the Italian market.

Highlights



A wide range available,
according to your needs



Protection rating
IP55 and IP66



Installation in
3-module boxes



Versatile. Can also be used
with Schuko 90° plugs



Wide. One of the **safest** and **most versatile** electrical sockets available today

The tiltable electrical outlet can be used with many of the most common types of plug, **including the Schuko plug with a 90° cable outlet**. The pressure exerted when **inserting the plug is sufficient to carry out the movement**. Wide guarantees the protection of the system and retains its **IP55** protection rating even with the plug connected when installed in its three-module flush-mounted box. What's more, it retains **IP66** protection when mounted in its wall-mounted enclosure. **Wide is compatible with a wide range of commercially available plugs**.



Wide adds **functionality** and **versatility**

The special **tilting movement** of the support on which the socket is mounted allows **many types of plugs** to be inserted, including the 90° Schuko plug.

45° tilting movement

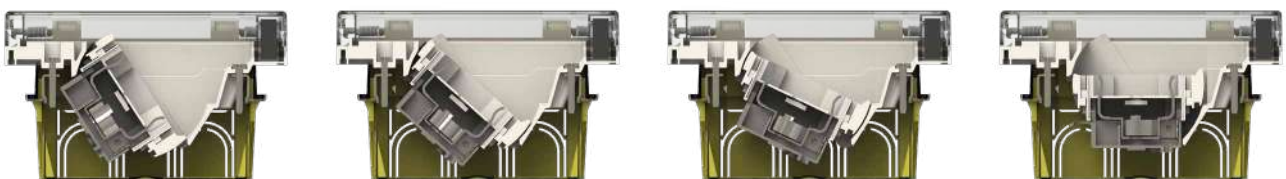

The only socket for 3-module boxes that is waterproof, even **with the plug connected**

No need to unplug in bad weather, as the protection level is maintained. Wide is the only 3-module outdoor flush-mounted socket outlet that can **guarantee** this kind of **performance**. Suitable for use in the home, outdoors, **swimming pools** and **garages**, and excellent in working environments, from **commercial kitchens** to **technical laboratories**. Whatever the application, **Wide** protects your **system** in complete safety.



The high-spec. waterproof 3-module back box



IP55 With flush-mounted box

Total protection against the ingress of solid objects.
Protection against drips, steam, splashes and water jets.



IP66 With wall box

Total protection against the ingress of solid objects and dust.
Protected against powerful jets of water from any direction.

Easy installation

Wide can be installed in standard **3-module flush-mounted boxes**. This makes it perfect for new installations or refurbishments as it uses the **existing box**. Retrofitting existing installations is easier because the 3-module boxes that are already installed can be reused allowing work to be carried out **without having to do invasive or expensive work**. As an alternative to the 3-module IP55 flush-mounted box version, Wide is also available in an **IP66** wall-mounted version.

What does IP rating mean?

The IP (Ingress Protection) rating is a common rating used in electrical engineering to indicate the degree of protection of a device against contact with solids and liquids.

Catalogue



4B.W.01
Wide IP55
frame only
**For 3-module
flush-mounted box**
White



4B.W.03
Wide IP55
frame only
**For 3-module
flush-mounted box**
Anthracite



4B.W.RAL
Wide IP55
frame only
**For 3-module
flush-mounted box**
RAL 7035



4B.W.CC03
**Portable IP66
socket with
3 m P40 cable**
Black



4B.W.AP
Pole-mounting
Accessory for
IP66 wall box
RAL 7035



4B.W.01.015
Wide IP55
complete with
bipasso Schuko socket
**for 3-module
flush-mounted box**
White



4B.W.03.015
Wide IP55
complete with
bipasso Schuko socket
**for 3-module
flush-mounted box**
Anthracite



4B.W.RAL.015
Wide IP55
complete with
bipasso Schuko socket
**for 3-module
flush-mounted box**
RAL 7035



4B.W.04.015
Wide IP55
complete with
bipasso Schuko socket
**for 3-module
flush-mounted box**
Forest green



4B.WB.01
IP66 wall box
for Wide
White



4B.WB.03
IP66 wall box
for Wide
Anthracite



4B.WB.RAL
IP66 wall box
for Wide
RAL 7035



4B.WB.04
IP66 wall box
for Wide
Forest green

Would you like to use **your own modules?**

If so, you can order the frame-only versions of Wide, which can be used exclusively with Vimar® Plana™ series modules.

Accessories

Plugs compatible with Wide

Italian standard

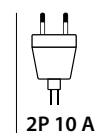

2P 10 A



2P+E 10 A

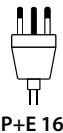

2P+E 16 A

German Standard

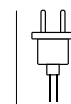

2P+E

4b Externa IP40 IP55

Externa IP40 and IP55 are designed to offer an all-in-one solution that includes both the wall-mounted box and pre-installed module. This means faster installation times, greater cost savings and a choice to use the features of Side, Side XL, Bitappo and Uniko.



Water and dust resistant

Externa is available in IP40 and IP55 versions, which means it is protected against **solid bodies** larger than 1 mm (IP40), **water jets** and **dust** (IP55).

Simple, but sophisticated

Externa IP40 and IP55 are the only **all-in-one** outdoor boxes. Their IP rating makes them **durable and functional**; the preinstalled modules make them **unique and special**. **Side** and **Side XL** means there is no longer any need to use an adaptor, and **Uniko** lets you to choose between a one-way, two-way switch, intermediate switch and push-button functions.

Catalogue

Externa IP40 3 modules



4B.IP40.H21.CU
Externa IP40
3 modules
complete with
Uniko and Side



4B.IP40.H21.XL
Externa IP40
3 modules
complete with
Side XL

Externa IP55 3 modules



4B.IP55.H21.CU
Externa IP55
3 modules
complete with
Uniko and Side



4B.IP55.H21.XL
Externa IP55
3 modules
complete with
Side XL

Highlights



all in one
product



Protection rating
IP40 and IP55



No need for
adaptors



Competitively
priced



Fast
installation

Externa IP40 2 modules



4B.IP40.BT.CU
Externa IP40
2 modules
complete with
Uniko and Bitappo



4B.IP40.H21
Externa IP40
2 modules
complete with
Side

Externa IP55 2 modules



4B.IP55.BT.CU
Externa IP55
2 modules
complete with
Uniko and Bitappo



4B.IP55.H21
Externa IP55
2 modules
complete with
Side

Find out about 4box products

Discover all the features of
preinstalled modules on
Externa IP40 and IP55.

For Side see page 8

For Side XL see page 14

For Bitappo see page 24

For Uniko see page 30

Plugs compatible with Externa IP40 | IP55

Italian standard

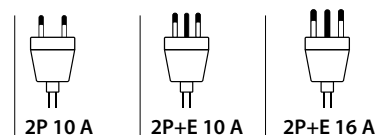

German Standard

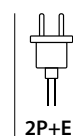

NEW S SERIES

4box's **smart devices** are a perfect fit for almost any type of installation: renovations, refurbishments or new-builds.

They are super easy to install and **require no gateway**. The S SERIES is based on Wi-Fi communication protocol, integrated into all 4box smart devices.

The product range includes:

- **P40 S**, a class-leading electrical socket from 4box
- **Uniko Lite S**, the 4box smart switch for controlling 1-way, two-way and intermediate switched circuits
- **Uniko Pro S**, the world's only multifunctional smart control for lights and shutters
- **Relè Lite S** e **Relè Pro S**, relays capable of making any system smart.

All S SERIES devices are compatible with Google Home and Amazon Alexa.

S SERIES is compatible with the most popular residential and commercial wiring accessory systems: Bticino® LivingLight™, LivingNow™ and Matix™; Vimar® Plana™ and Arké™.

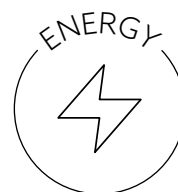

4b P40 S



4b Uniko Lite S



4b Uniko Pro S



4b Relè Lite S



4b Relè Pro S



The benefits of a smart home

Convenience: remote control and automation of devices make household tasks easier

Energy saving: intelligent energy management to reduce unnecessary consumption

Safety: real-time monitoring of major household appliances

Automation: save time by automating daily tasks

Accessibility: easy to use and intuitive app

Remote management: control of home functions from your mobile devices

Customization: create scenarios and automation to make your living space unique and personal

Resource management: monitor energy consumption to reduce waste



The **4box** app. Customizing your living space

To provide an exceptional level of convenience and control, we have developed a **dedicated app for the S SERIES**: not only does it simplify management, it also makes monitoring and interacting with your devices child's play.

With this app, you can **centralize control of all your 4box S Series products in a single control**. One touch is all it takes to customize your living space.

However, the app's functionality does not stop there. You can manage functions, configure devices, create scenarios and routines, enable voice assistants, and monitor and manage the power consumption of your devices.

The app you can't live without!

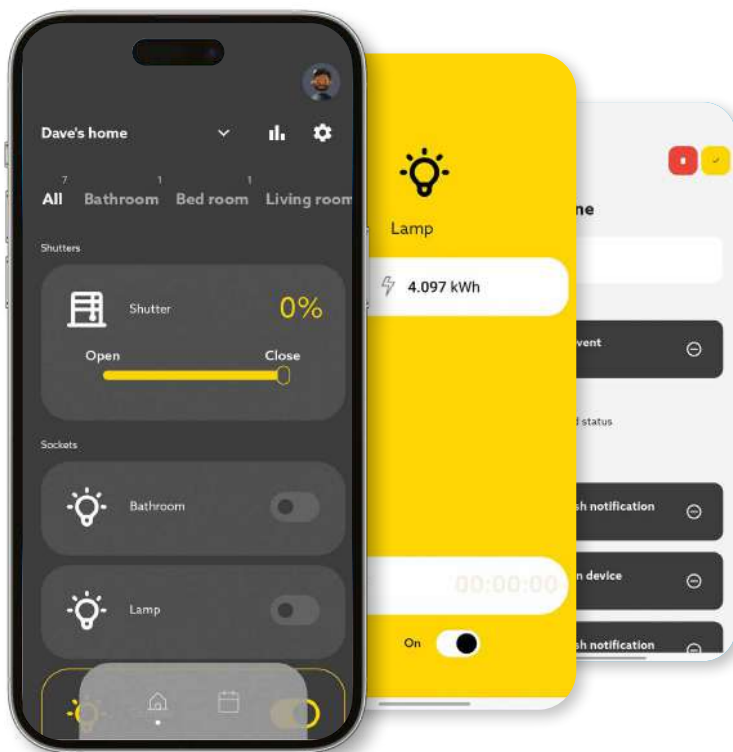

4b P40 S

P40 S is the intelligent electrical socket from 4box that revolutionizes your home. Energy consumption is indicated via the built-in LED. It is also fitted with a 16 A relay and can be connected to Wi-Fi without needing a gateway.

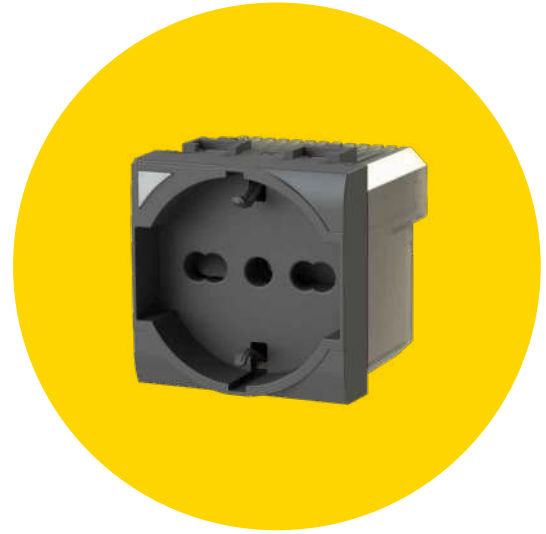

Total control with a single socket

Monitor your energy consumption in real time with the P40 S built-in energy meter and LED and you always know how much power is being used. The socket is also fitted with a **temperature sensor** that shuts the power off in case of overheating.

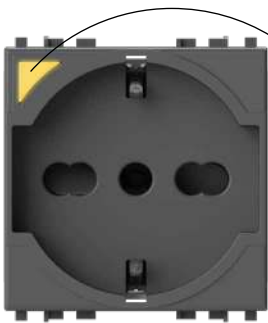

Micro Switch Button with RGB status LED indicating consumption from 0 W to 3,000 W

Compatible with the most popular residential and commercial wiring accessory systems

Bticino®
Matix™, LivingLight™, LivingNow™

Vimar®
Plana™, Arkè™

Intuitive

Monitor your energy consumption in real time with the P40 S. The LED, fitted in the top left hand corner, indicates the current energy consumption with the following simple colour scheme.

-  From 0 W to 100 W the LED turns blue
-  From 100 W to 200 W the LED turns green
-  From 200 W to 400 W the LED turns yellow
-  From 400 W to 1000 W the LED turns orange
-  From 1,000 W to 2,500 W the LED turns red
-  From 2,500 W to 3,000 W the LED turns purple

Highlights



Built in
energy meter



No need for
a gateway



Fitted with a
16 A relay



Connection
via Wi-Fi



Auxiliary terminals IN and OUT
to connect external devices



Compatible with
Google Home and Amazon Alexa



P40 S. Packed with power and technology

4box transforms the classic P40 electrical outlet into a technology powerhouse with smart functions. The P40 S (Schuko + 10/16 A) is equipped with a multifunctional **Micro Switch Button** with RGB LEDs, that together with the **Integrated Energy Meter**, instantly measures consumption. The Wi-Fi antenna allows the P40 S to be connected easily to all compatible devices.

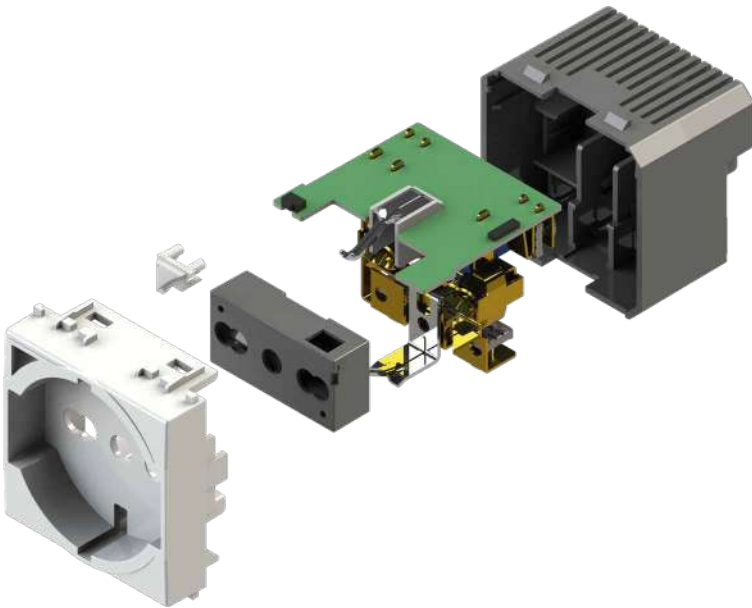

Connection diagram

Rear 'IN' terminal for connecting 12 switches or push-buttons to control the relay on the P40 Smart. Rear 'OUT' terminal for routing the phase line to another non-Smart socket, so that the latter can be controlled in parallel with the P40 S. Phase, neutral and earth terminals for connection to N mains power supply.

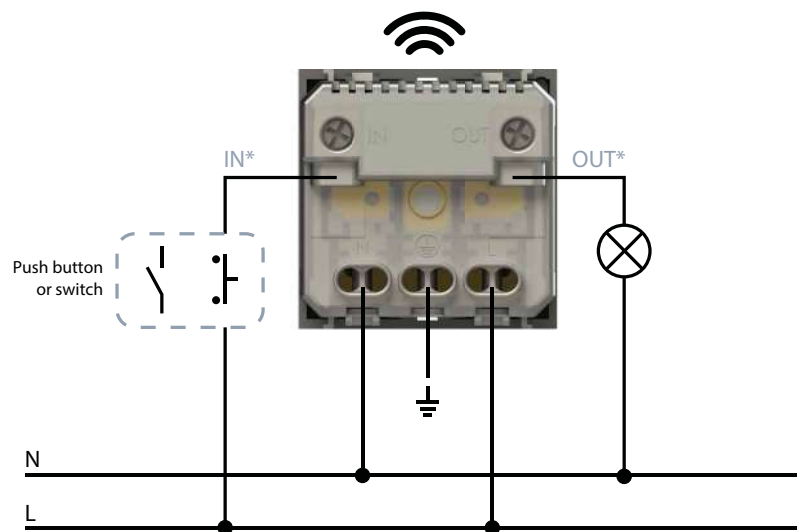

*Optional

Catalogue

P40 S – compatible with Bticino®



4BP40S.AM
P40 S for
Matix™
White

P40 S – compatible with Vimar®



4BP40S.V14
P40 S for
Plana™
White



4BP40S.N
P40 S for
LivingLight™
White



4BP40S.L
P40 S for
LivingLight™
Anthracite



4BP40S.NT
P40 S for
LivingLight™
Tech



4BP40S.V19B
P40 S for
Arkè™
White

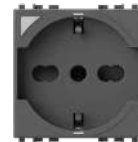

4BP40S.V19
P40 S for
Arkè™
Grey



4BP40S.V19M
P40 S for
Arkè™
Metal



4BP40S.KW
P40 S for
LivingNow™
White



4BP40S.KG
P40 S for
LivingNow™
Anthracite



4BP40S.KM
P40 S for
LivingNow™
Sand

Plug compatible with P40 S

Italian standard

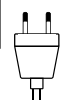

2P 10 A

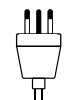

2P+E 10 A

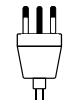

2P+E 16 A

German standard



2P+E

4b Uniko Lite S

Uniko has evolved with its new Lite S version: one switch, more possibilities. Uniko Lite S lets you start scenarios, set routines via the app, or control the load. There is a LED on the front that lights up according to its use. Uniko Lite S. Now better than ever!



A single switch that gives you **total control**

The app allows real time display of energy consumption. The internal 7 A relay enables smart control of the connected light.

Compatible with the most popular residential and commercial wiring accessory systems

Bticino®
Matix™, LivingLight™, LivingNow™

Vimar®
Plana™, Arkè™

More **flexible**

Depending on the configuration, **Uniko Lite S** can be installed as a one-way switch, two-way switch, intermediate switch or as a push-button (NO/NC). It can also be used to **start a scenario**.

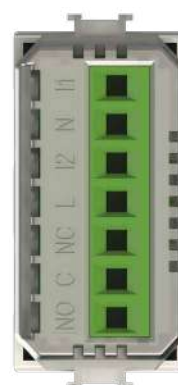

Highlights



Allows you to control
1 light point



Connection
via **Wi-Fi**



No need
for a gateway



Compatible with
Google Home and Amazon Alexa



Status
RGB LED



Uniko Lite S. Simple but special

The basic functions of the Uniko Lite S include **bistable control** (allowing the product to be used as a one-way switch, two-way switch or intermediate switch) and **monostable control** (NO/NC push-button function). In addition, Uniko Lite S lets you manage lighting scenarios, so that you can create the right atmosphere with a simple voice command.

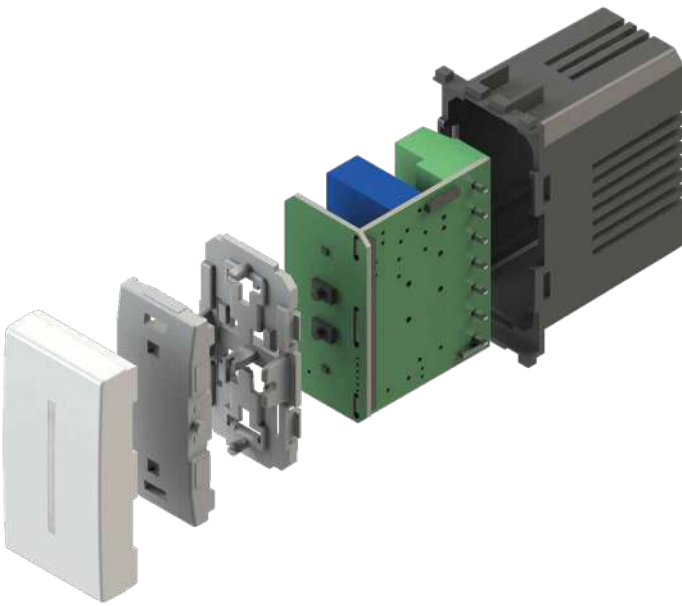

Connection diagram

- Terminals I1 and I2 for optional push-button inputs
- Neutral N terminal
- Terminals L phase in
- NC and NO terminals for connecting normally open or normally closed contacts
- Terminal C load connection

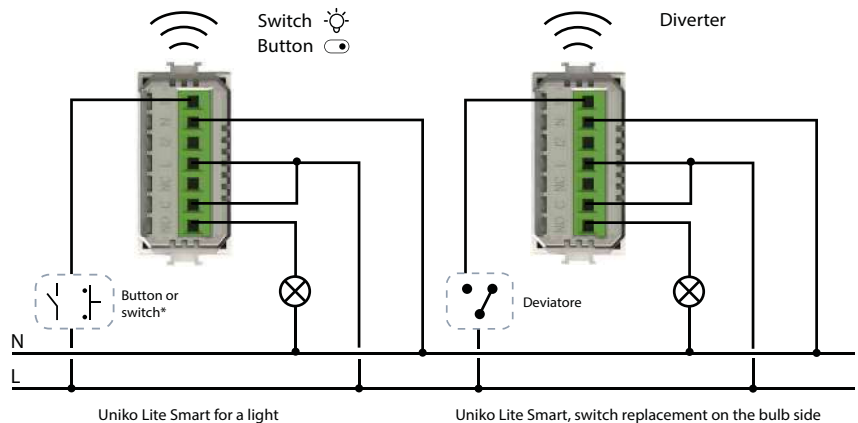

* In the input it can be connected indiscriminately to Phase (L) or to Neutral (N)
 Switch: set it as default in case no input commands are present
 Button: the command from the app closes the contact for one second

Catalogue

Uniko – compatible with Bticino®



4BCU1S.AM
Uniko Lite S for
Matix™
White

Uniko Lite S – compatible with Vimar®



4BCU1S.V14
Uniko Lite S for
Plana™
White



4BCU1S.N
Uniko Lite S for
LivingLight™
White



4BCU1S.L
Uniko Lite S for
LivingLight™
Anthracite



4BCU1S.NT
Uniko Lite S for
LivingLight™
Tech



4BCU1S.V19B
Uniko Lite S for
Arkè™
White



4BCU1S.V19
Uniko Lite S for
Arkè™
Grey



4BCU1S.V19M
Uniko Lite S for
Arkè™
Metal



4BCU1S.K
Uniko Lite S for
LivingNow™
to be completed with
Bticino® cover

Uniko Lite S applications

One-way switch

Two-way switch

Intermediate switch

Push-button (NO/NC)

4b Uniko Pro S

Uniko Pro S is the multi-functional device brought to you by 4box. In addition to the functions already available in the Lite version, it lets you control two lighting points. With its two built-in relays, it can control the motors of shutters, roller blinds and awnings, and can be operated automatically, even when you are not at home.

Almost everything you need in **one device**

Multiple functions in a single switch – this is the strength of Uniko Pro S. It has two built-in status LEDs and two (2x 5 A) relays to control 2 lighting points or a roller shutter. The Wi-Fi antenna lets you use these features locally and through app and voice assistants. What's more, the Uniko Pro S lets you **monitor energy consumption** via the app in real time.

Compatible with the most popular residential and commercial wiring accessory systems

Bticino[®]
Matix[™], LivingLight[™], LivingNow[™]

Vimar[®]
Plana[™], Arkè[™]



Intuitive

Uniko Pro S is a multifunctional switch. Other non-smart commands can be connected to terminals 'IN1' and 'IN2'. The terminals 'NO1' and 'NO2' are used to connect output lines with a separate neutral. The phase-neutral terminals allow connection to the mains power supply.

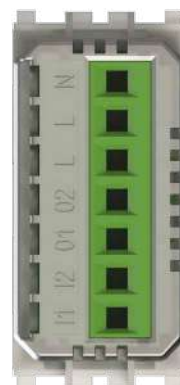

Highlights



Lets you to control
2 lighting points or 1 roller shutter



Connection
via **Wi-Fi**



No need for
a gateway



Compatible with
Google Home and Amazon Alexa



RGB LED



Built-in
energy meter



Uniko Pro S. Almost magical!

The basic functions of the Uniko Pro S include **bistable control** (allowing the product to be used as a one-way switch, two-way switch or intermediate switch) and **monostable control** (push-button function).

In both cases, it can control 2 lights or the motor of roller shutters or curtains.

In addition, Uniko Pro S lets you manage lighting scenarios so you can create the right atmosphere, that you can also do using voice commands.

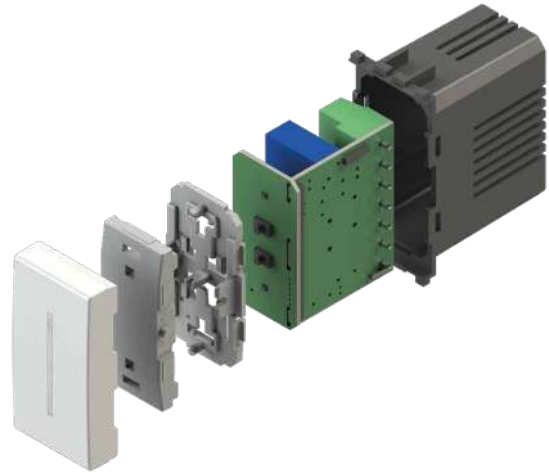

Connection diagram

- Terminals I1 and I2 for optional push-button inputs
- Terminals O1 and O2, return the device phase for load connection
- Phase terminals L (not to be used to derive other network loads)
- Neutral N terminal

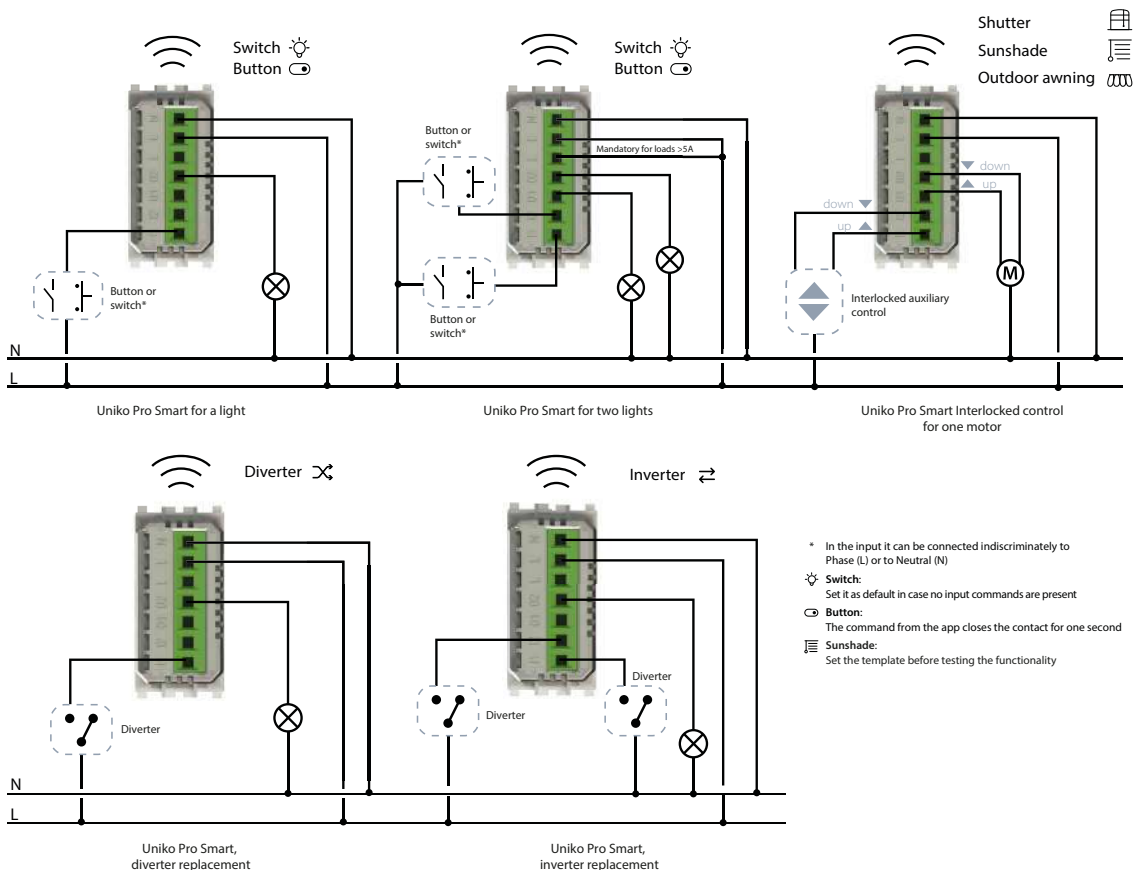

Catalogue

Uniko Pro S – compatible with Bticino®



4BCU2S.AM
Uniko Pro S for
Matix™
White



4BCU2S.N
Uniko Pro S for
LivingLight™
White



4BCU2S.L
Uniko Pro S for
LivingLight™
Anthracite



4BCU2S.NT
Uniko Pro S for
LivingLight™
Tech



4BCU2S.K
Uniko Pro S for
LivingNow™
to be completed with
Bticino® cover

Uniko Pro S – compatible with Vimar®



4BCU2S.V14
Uniko Pro S for
Plana™
White



4BCU2S.V19B
Uniko Pro S for
Arkè™
White



4BCU2S.V19
Uniko Pro S for
Arkè™
Grey



4BCU2S.V19M
Uniko Lite S for
Arkè™
Metal

Uniko Pro S applications

One-way switch

Two-way switch

Intermediate switch

Push-button (NO/NC)

Roller shutter control

4b Relay Lite S | Pro S

Relay Lite S and Relay Pro S are the epitome of compatibility! From now on, it doesn't matter which wiring accessory products you use. Thanks to 4box, any installation can become intelligent. Relay Lite S and Relay Pro S – the smart home for everyone.

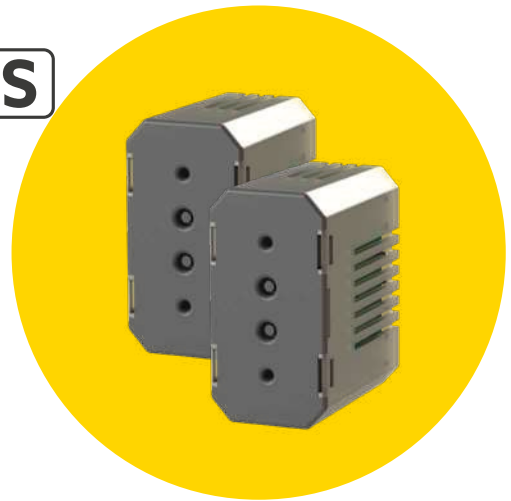

Two commands for almost every need

Relay Lite S is the intelligent single channel relay actuator that can control a single light point up to 7 A.

Relay Pro S is the intelligent dual channel (2x5 A) relay actuator that can control two lighting points or a motor. They can also be controlled via the app as well as monitoring real-time energy consumption.

Widely compatible

Thanks to 4box, any system can become smart. Relay Lite S and Relay Pro S ensure compatibility regardless of the residential and commercial wiring accessory systems in use. Place the relay in a junction box or behind a blanking plate and make any system smart. Simple, fast and economical.



Relay Lite S

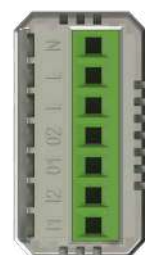

Relay Pro S

Highlights



Lets you to control
2 lighting points or 1 roller shutter



Connection
via **Wi-Fi**



No need for
a gateway



Compatible with
Google Home and Amazon Alexa



Built-in
energy meter

The right atmosphere at the right time

Relay Lite S and Relay Pro S come with a Wi-Fi and Bluetooth antenna, letting you to enjoy a range of smart interactions.

Use the app to create your own routines, ask voice assistants to activate a scenario and track all energy consumption in real time directly from your smartphone.

Always a good awakening

Relay Pro S lets you to control the motor of roller shutters or awnings. Set a routine and they will open at the set time in the morning and close automatically in the evening. You can also use voice assistants to open and close them without lifting a finger. Waking up has never been better.

Catalogue

Relay Lite S



4BCU1S.DER
Relay Lite S,
single channel relay

Relay Pro S



4BCU2S.DER
Relay Pro S,
double channel relay

Application of use

Smart technologies can be used to automate a range of activities and processes in the home to optimize energy consumption and provide greater convenience.

It's not home automation – it's just easier!

However, there are important differences: home automation includes all systems and devices that improve the comfort and efficiency of the home through functions integrated and wired into the electrical system. Smart homes, on the other hand, refer to the Internet of Things (IoT) and includes all products that use Internet connectivity and smartphone apps to offer new functions with traditional everyday objects such as lights, thermostats and shutters.

Create your own scenarios, and manage them using voice commands

Just ask and it will be done! Thanks to voice assistants you can change lighting scenarios, manage blinds, shutters and much more.



The perfect ambiance in your home

Let the intelligence of 4box Smart devices automatically manage your outdoor lighting according to the time of day and your location.

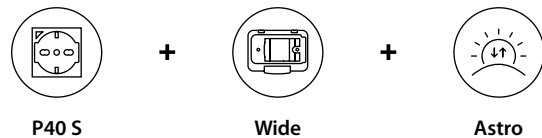

Everything is under control

Receive a notification when a connected device switches on or off, or if it exceeds a pre-set usage time.

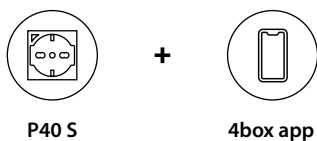

Set timers and routines

Prepare the house for the night with a simple command. Set timers and routines with the advanced functions of 4box smart products.





4box.it

One site for **all the information you need** – at your **fingertips**

On the **4box.it** website, available in the download area, you can find **all the technical data and installation information** regarding the full range of products, and the updated **price lists**.

Enter the world of 4box right now!

**Scan the QR
code to see the
download area**

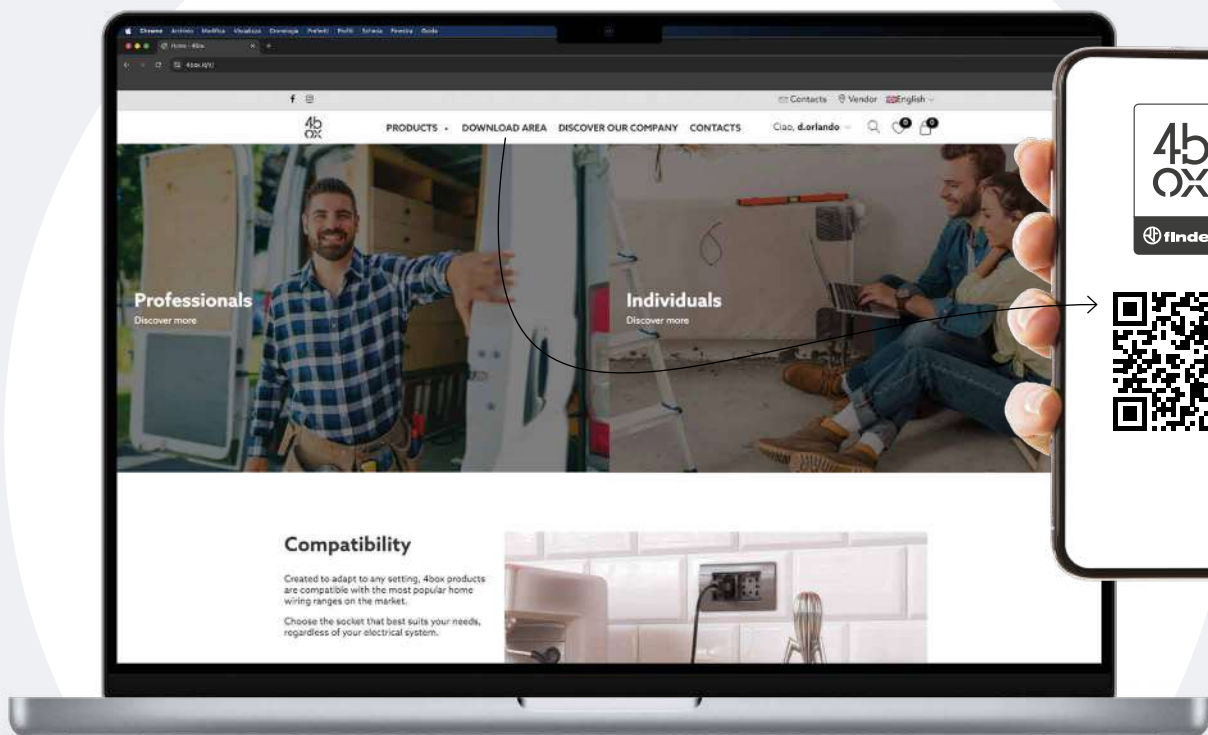



Copyright

The images in this catalogue are the property of Finder S.p.A., who owns the intellectual property rights and the rights of use and reproduction.

No part of this catalogue may be reproduced without the prior written permission of Finder S.p.A. Trademarks and trade names that appear in this publication are the property of their respective owners. The declared insulation performance was valid at the time of printing. Finder S.p.A. and 4box s.r.l. does not manufacture or market cover plates, frames or modules that are part of other companies' residential and commercial wiring accessory systems.

For the availability of these materials, please contact the respective company's sales network. Trademarks are the property of their respective owners.



2024
catalogue

Follow us on social media

findernet.com | 4box.it

Instagram
[@finderitalia](https://www.instagram.com/finderitalia) | [@4box_official](https://www.instagram.com/4box_official)

Facebook
[@Finder Italia](https://www.facebook.com/finderitalia) | [@4boxsocial](https://www.facebook.com/4boxsocial)

Youtube
[@FinderItalia](https://www.youtube.com/@FinderItalia) | [@4Box Official Channel](https://www.youtube.com/@4BoxOfficial)

Linkedin
[@finder-relays](https://www.linkedin.com/company/finder-relays)

X
[@finderitalia](https://twitter.com/finderitalia)



Prices, features, specifications, capabilities, appearance and availability of our products and services are subject to change without notice. FINDER assumes no responsibility for the presence of possible errors or insufficient information in this document. In case of discrepancies between the printed and online versions, the latter prevails.

ZCTENEN4BOX - VIII/2024 - 4box catalogue