

4b  
OX

 finder®

2025  
catalogue



**FOR AN INNOVATIVE  
AND PRACTICAL  
ELECTRICAL INSTALLATION**

*Patented power sockets, USB power supplies,  
smart controls, and much more*



**2025**  
catalogue

# 4box

offers a wide range of modern solutions that revolutionize the world of **electrical switches and sockets**.

**User-friendly and innovative**, making installation an **easy, fast and safe**. **Side, P503 and USBP40** are patented devices that demonstrate a true evolution.

4box also boasts products such as **Wide, Uniko** and the **20 W Power Delivery USB** power supplies.





## 4box – Now part of the Finder Group

Finder and 4box share a culture based on the **quest for simple and original solutions** that provide added value for the customer. The merger of these two entities aids the development and distribution of **new products and technologies**, offering excellent customer support.

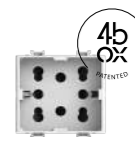

# Contents

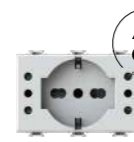





## P SERIES p.06

				
<b>4b Side</b>	<b>4b Side XL</b>	<b>4b P40</b>	<b>4b P503</b>	<b>4b Bitappo</b>
p.08	p.14	p.16	p.20	p.24

## C SERIES p.28

<b>4b Uniko</b>
p.30



## U SERIES p.38

					
<b>4b USB 2.1</b>	<b>4b USB 2.4</b>	<b>4b USB CA 20W</b>	<b>4b USB CCA 20W</b>	<b>4b USBP40 3.0</b>	<b>4b USBP503</b>
p.40	p.40	p.44	p.48	p.52	p.56

## B SERIES p.60

				
<b>4b Libero</b>	<b>4b Cover Plates</b>	<b>4b Bundle</b>	<b>4b Hide</b>	<b>4b Titappo</b>
p.62	p.66	p.70	p.72	p.76

## E SERIES p.78

		
<b>4b Wide</b>	<b>4b Externa IP40</b>	<b>4b Externa IP55</b>
p.80	p.86	p.86

## S SERIES p.88

				
<b>4b P40 S</b>	<b>4b Uniko Lite S</b>	<b>4b Uniko Pro S</b>	<b>4b Relay Lite S</b>	<b>4b Relay Pro S</b>
p.92	p.96	p.100	p.104	p.104





# P SERIES

The **P SERIES** is compatible with Bticino®, Vimar® and Gewiss® product ranges. 4box's strict safety and quality standards ensure the highest level of product reliability and durability for both installer and end user.

**P SERIES. Patented and innovative electrical sockets.**



4b Side



4b Side XL



4b P40



4b P503



4b Bitappo



# 4b Side

Thanks to Side, you can eliminate the need for adaptors. With just two modules, you can now enjoy the functionality of two types of socket. You can use either one Schuko socket, or two bipasso sockets. Side is compatible with the most popular residential and commercial electrical wiring systems.



## Three times one equals one!

The module includes one Schuko socket or two bipasso sockets. It's a new and innovative multi-socket concept that eliminates the need for adaptors.

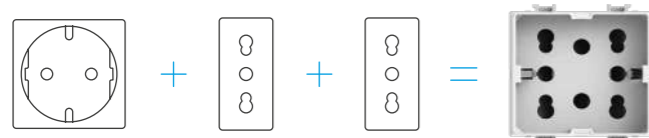

## Compatible with the most popular residential and commercial wiring accessory systems

**Bticino®**  
Matix™, Matix Magic™, LivingLight™, Idrobox™ enclosures

**Vimar®**  
Plana™, Arkè™, Eikon™, IsoSet™ enclosures

**Gewiss®**  
System™, Chorus™, Combi™ enclosures

Designed and patented in Italy, Side is one of a number of 4box products that are unique in their field.

## Schuko, bipasso, or Side!



## Highlights

- Three sockets in one**, one Schuko or two bipasso
- Competitively priced**
- Compatible** with the most popular residential and commercial wiring accessory systems
- A single terminal block for **quick and easy installation**
- No need for adaptors**
- Side is a **patented product**





### Focused creativity

Side is one of 4box's most significant innovations. The concept is really simple, but the result is amazing: **three different types of electrical outlets in a single module.**

### The 4 features of Side



#### 1. No more adaptors

With Side you can connect devices fitted with Schuko plugs without the need for adaptors.



#### 2. Saves space

With Side you can use two 10 A or 16 A plugs at the same time in a single module.



#### 3. Versatile

With Side you can use Italian Standard (2P 10 A, 2P+E 10 A, 2P+E 16 A) and German Standard (2P+E) plugs.



#### 4. Easy to install

Side is fitted with a single terminal block, which makes installation quicker and easier.

### 4b Side | FOR EXTERNA\* IP40 AND IP55

Side is also available in Externa IP40 and IP55 versions to provide greater functionality and versatility in environments where such equipment is required by regulations. Side eliminates the need for adaptors to connect vacuum cleaners, pressure washers, lawnmowers, compressors or household appliances. Maximum safety and compliance with regulations all in one socket.

*\*You can find Externa IP40 and IP55 on page 86*



### 4b Side | FOR PANELS

Side is the socket that does not require a mounting frame to install the socket outlet.

Ideal for workstations, office furniture, rack panels and railway rolling stock.



### 4b Side | FOR HIDE\*

Innovate to the maximum with 4box. Side can also be used together with Hide – another 4box innovation.

*\*You can find Hide on page 72*



# Catalogue



Side is compatible with the most popular residential and commercial wiring accessory systems. See below for cross-reference chart and part numbers.

## Plugs suitable for use with Side

### Italian standard

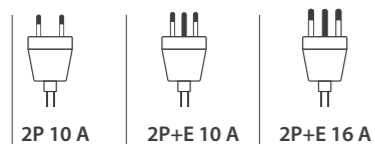

### German standard

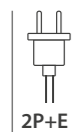

## Side – compatible with Bticino®



4B.AM.H21 Side for Matix™ White  
 4B.AMR.H21 Side for Matix™ Red  
 4B.A.H21 Side for Matix Magic™ Ivory



4B.N.H21 Side for LivingLight™ White  
 4B.L.H21 Side for LivingLight™ Anthracite  
 4B.NT.H21 Side for LivingLight™ Tech



4B.LR.H21 Side for LivingLight™ Red

## Side – compatible with Vimar®



4B.V14.H21 Side for Plana™ White  
 4B.V14SL.H21 Side for Plana™ Silver  
 4B.V14R.H21 Side for Plana™ Red



4B.V19B.H21 Side for Arkè™ White  
 4B.V19.H21 Side for Arkè™ Grey  
 4B.V19R.H21 Side for Arkè™ Red



4B.V19M.H21 Side for Arkè™ Metal



4B.V20B.H21 Side for Eikon™ White  
 4B.V20.H21 Side for Eikon™ Grey  
 4B.V20N.H21 Side for Eikon™ Next



4B.V20R.H21 Side for Eikon™ Red

## Side – compatible with Gewiss®



4B.G20.H21 Side for System™ White  
 4B.G20R.H21 Side for System™ Red



4B.G10.H21 Side for Chorus™ White  
 4B.G12.H21 Side for Chorus™ Black  
 4B.G14.H21 Side for Chorus™ Titanium

## Side for panels



4B.SP.BN Side for panels White  
 4B.SP.AN Side for panels Anthracite



# 4b Side XL

The designers of Side have created a unique, revolutionary socket: Side XL. This new electrical outlet is practical, convenient, compatible with the most popular residential and commercial wiring accessory systems, and competitively priced.

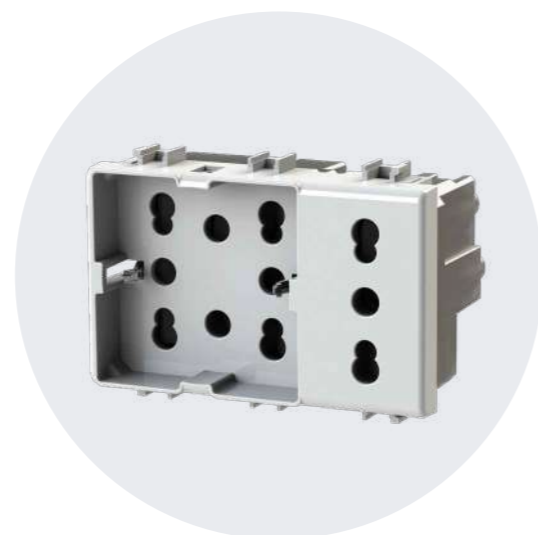

## Four sockets in one

One Schuko and one bipasso or three bipasso sockets in just three modules. You can also use a bipasso and a Schuko socket simultaneously.



**Compatible** with the most popular residential and commercial wiring accessory systems

Bticino®  
Matix™, LivingLight™

Vimar®  
Plana™



## Highlights

- Four sockets in one**, one Schuko and one bipasso or three bipasso sockets
- Competitively priced**
- Compatible** with the most popular residential and commercial wiring accessory systems
- Side XL is **patented**
- No need for adaptors**

## Catalogue

Side XL – compatible with Bticino®



4B.AM.H21.XL  
Side XL for  
Matix™  
White



4B.N.H21.XL  
Side XL for  
LivingLight™  
White



4B.L.H21.XL  
Side XL for  
LivingLight™  
Anthracite



4B.NT.H21.XL  
Side XL for  
LivingLight™  
Tech

Side XL compatible with Vimar®



4B.V14.H21.XL  
Side XL for  
Plana™  
White



Plugs suitable for use with Side XL

Italian standard

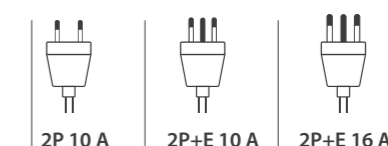

German standard

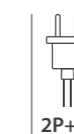

# 4b P40

The new universal standard socket from 4box. P40 gives you the functionality of the two most commonly used electrical sockets in a single module: a Schuko socket or a bipasso socket. P40 is available for the most popular residential and commercial wiring accessory systems.



## Highlights

- ✕

No need for  
**adaptors**
- €

**Competitively  
priced**
- ⊖

**Compatible** with the most  
popular residential and commercial  
wiring accessory systems
- ☀

Option of making P40  
**an illuminated device**
- ✂

**No more tools!**  
Built-in wires

**Compatible** with the most popular residential and commercial wiring accessory systems

Bticino®  
Matix™, LivingLight™

Vimar®  
Plana™, Arkè™

Gewiss®  
System™

## Compatible

P40 perfectly matches the look of the most popular residential and commercial wiring accessory systems, providing a viable alternative to more traditional sockets on the market.

## Innovative

The innovative built-in wire **Stripper** allows you to **strip** 1.5 mm<sup>2</sup> and 2.5 mm<sup>2</sup> diameter wires without tools.

## Flexible

A solution that allows you to create an electrical system that is **flexible** and **better suited to your needs**.



# Catalogue

## The new 4box universal socket

4box has expanded its range with the new universal socket. The new socket outlet is practical, convenient and compatible with the most popular residential and commercial electrical wiring systems. It is also competitively priced.

### Plugs suitable for use with P40

#### Italian standard

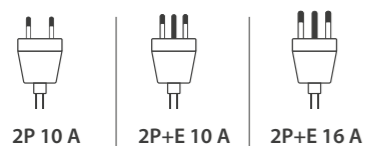

#### German standard

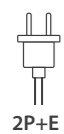

### P40 – compatible with Bticino®



**4B.AM.P40**  
P40 for  
Matix™  
White



**4B.AMR.P40**  
P40 for  
Matix™  
Red



**4B.N.P40**  
P40 for  
LivingLight™  
White



**4B.NT.P40**  
P40 for  
LivingLight™  
Tech



**4B.L.P40**  
P40 for  
LivingLight™  
Anthracite



**4B.LR.P40**  
P40 for  
LivingLight™  
Red

### P40 – compatible with Vimar®



**4B.V14.P40**  
P40 for  
Plana™  
White



**4B.V14R.P40**  
P40 for  
Plana™  
Red



**4B.V19.P40**  
P40 for  
Arke™  
Grey



**4B.V19B.P40**  
P40 for  
Arke™  
White



**4B.V19M.P40**  
P40 for  
Arke™  
Metal

### P40 – compatible with Gewiss®



**4B.G20.P40**  
P40 for  
System™  
White



**4B.G20R.P40**  
P40 for  
System™  
Red



# 4b P503

P503 offers the best possible performance whilst allowing you to optimize the available space.

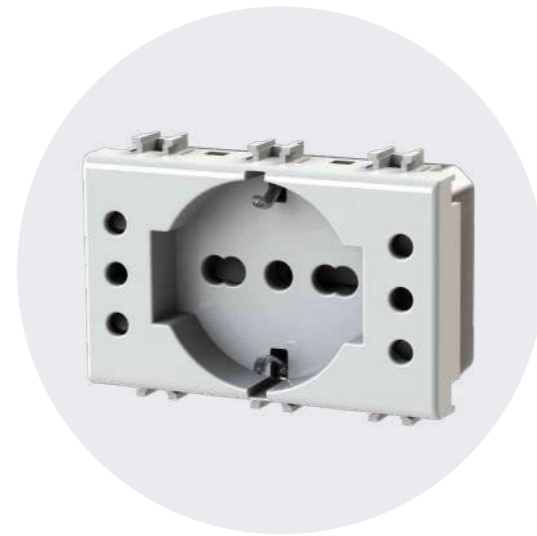

## The new multi-socket standard in just 3 modules

The P503 is a flush-mounted socket that houses a universal Schuko socket, three 10 A sockets and one 10/16 A socket in just three modules. P503 is fitted with a **single power terminal block** for quick and easy installation.

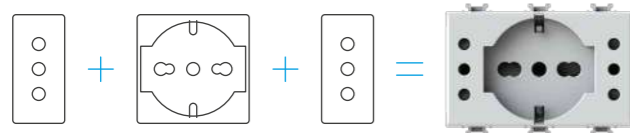

## Compatible with the most popular residential and commercial wiring accessory systems

Bticino®  
Matix™, LivingLight™, LivingNow™

Vimar®  
Plana™, Arkè™

## Highlights

- 5

**Five sockets in one**, one Schuko, 3 10 A sockets and one 10/16 A socket
- €

**Competitively priced**
- ⊗

**Compatible** with the most popular residential and commercial wiring accessory systems
- ⚙️

A single terminal block for **quick and easy installation**
- ⊗

No need for **adaptors**
- ®

P503 is a **patented** product

## Widely compatible

P503 is **compatible in finish and colour** to the Home range, making it a viable alternative to traditional sockets.

## Innovative

A **single power terminal block** makes installation quicker and requires no masonry work. **The new standard in just 3 modules.**

## Flexible

A **flexible solution** that allows you to create the perfect system for your requirements.



## Is it magic? No, just innovation



### 1. No more adaptors

With P503, you can connect devices fitted with Schuko plugs without the need for adaptors.

### 2. Saves space

With P503, you can use three plugs at the same time in a single three-module outlet.

### A single power supply terminal

P503 is fitted with a single terminal block for quick and easy installation.

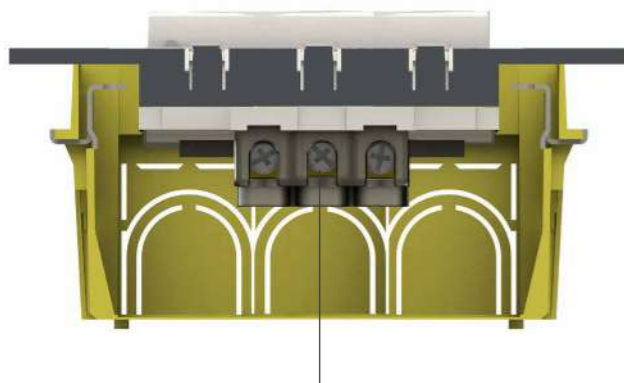

- A single power supply terminal block makes wiring quick and easy.
- The space available for cable routing from the bottom is between 1.7 cm and 2 cm depending on the box model.

#### Did you know that...

10 A plugs are used for:

- PC Monitors
- Laptops
- Hair straighteners
- Dehumidifiers
- Electric toothbrushes
- Soundbar speakers
- Televisions
- Stereo hi-fi systems
- Fans
- Air fryers
- Blenders and juicers
- Gaming consoles
- Voice assistants
- Cordless vacuum cleaners

Anything else?

No problem, P40 will probably do the job.

## Catalogue

### P503 – compatible with Bticino®



4BP503.AM  
P503 for  
Matix™  
White

### P503 – compatible with Vimar®



4BP503.V14  
P503 for  
Plana™  
White



4BP503.L  
P503 for  
LivingLight™  
Anthracite



4BP503.N  
P503 for  
LivingLight™  
White



4BP503.NT  
P503 for  
LivingLight™  
Tech



4BP503.V19  
P503 for  
Arke™  
Grey



4BP503.V19B  
P503 for  
Arke™  
White



4BP503.V19M  
P503 for  
Arke™  
Metal

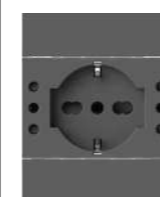

4BP503.KG  
P503 for  
LivingNow™  
Black



4BP503.KM  
P503 for  
LivingNow™  
Sand



4BP503.KW  
P503 for  
LivingNow™  
White

### Plugs suitable for use with P503

#### Italian standard

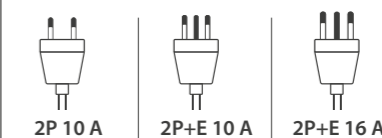

#### German standard

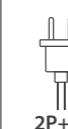

# 4b Bitappo

Bitappo is the innovative solution from 4box designed to simplify and speed up the installer's work. One 10/16 A socket and 2 blanking plates ready to be installed. If necessary, the blanking plates can be removed to create a different socket configuration.



## Highlights

- 1 Just one product per socket outlet, one bipasso socket and two blanking plates
- € Competitively priced
- Compatible with the most popular residential and commercial wiring accessory systems
- Quick and easy to install
- No more tools! Built-in wire Stripper

A ready-to-use, simple and innovative socket.



### Faster

A 'ready to go' solution that reduces installation time.

### Easier

A solution that simplifies project design and quotations.

### Innovative

The innovative built-in wire Stripper, lets you strip 1.5 mm<sup>2</sup> and 2.5 mm<sup>2</sup> diameter wires without any tools.

Compatible with the most popular residential and commercial wiring accessory systems

Bticino®  
Matix™, LivingLight™

Vimar®  
Plana™, Arkè™

Gewiss®  
System™





## Choose, snap off and install

Bitappo was designed to make your work **easier and faster**. The practicality you have been waiting for in a single, ready-to-use modular product that **you can take apart and reassemble at will** to create ever-changing solutions to customize your socket.



1. Choose



2. Snap off



3. Install

## Stripper! An ingenious solution

4box presents **Stripper**, a solution as simple as it is **ingenious** that allows you to **strip wires** of two different diameters, speeding up the installation process and eliminating the need for other tools.



### 1. Choose the diameter

Turn the blanking plate over and you will find two notches for stripping 1.5 mm<sup>2</sup> and 2.5 mm<sup>2</sup> diameter wires.



### 2. Insert the wire

Once you have selected the notch, insert the wire to be stripped.



### 3. Press and cut

Gently press and rotate the wire against the sharp edge of the notch to cut the insulation.



### 4. Pull the wire

Pull the wire outwards to strip the insulation.

## Catalogue

### Bitappo – compatible with Bticino®



4B.AM.BT  
Bitappo for  
Matix™  
White

### Bitappo – compatible with Vimar®



4B.V14.BT  
Bitappo for  
Plana™  
White



4B.N.BT  
Bitappo for  
LivingLight™  
White



4B.L.BT  
Bitappo for  
LivingLight™  
Anthracite



4B.NT.BT  
Bitappo for  
LivingLight™  
Tech

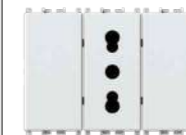

4B.V19B.BT  
Bitappo for  
Arkè™  
White



4B.V19.BT  
Bitappo for  
Arkè™  
Grey



4B.V19M.BT  
Bitappo for  
Arkè™  
Metal

### Bitappo – compatible with Gewiss®



4B.G20.BT  
Bitappo for  
System™  
White

### Plugs compatible with Bitappo

#### Italian standard

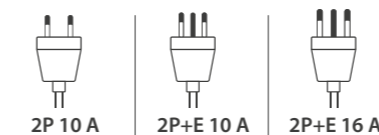



## C SERIES

Simplifying the installation process is one of 4box's main objectives.

Uniko is a multifunction-switch compatible with the main residential and commercial wiring accessory systems from Bticino®, Vimar® and Gewiss®. It provides for five functions to be implemented in a single device, depending on how the terminals are configured.

**One-way switch, two-way switch, intermediate switch and NO/NC push-button** in one control for maximum flexibility and speed of installation.

**C SERIES. Multiple advantages in a single code.**



4b Uniko





# 4b Uniko

Uniko has 5 functions.

One-way switch, two-way switch, intermediate switch and NO or NC push button, depending on how the terminals are configured.

Uniko from 4box is compatible with the main residential and commercial wiring accessory systems.



## Highlights

- 5** Five in one: one-way switch, two-way switch, intermediate switch and NO/NC push-button
- ↻** No need to change function
- ⊕** Compatible with the most popular residential and commercial wiring accessory systems

- €** Competitively priced
- ☀** Option of making Uniko an illuminated device
- ®** Uniko is patented



**Compatible** with the most popular residential and commercial wiring accessory systems

Bticino®  
Matix™, LivingLight™

Vimar®  
Plana™, Arkè™, Eikon™

Gewiss®  
System™, Chorus™

## Convenient

You decide how to use Uniko. If you need to replace a faulty switch, you always have what you need.

## Cost-effective

It is also competitively priced. Uniko offers its many solutions at a **competitive price** compared to traditional switches.

## Widely compatible

Uniko is **compatible in finish and colour** to the residential and commercial wiring accessory systems, making it a viable alternative to traditional switches.





## From a push-button to a rocker switch in just one simple step

An innovative mechanism for engaging and disengaging the spring inside the switch, using a standard Phillips or slotted screwdriver, lets you use Uniko as a rocker switch or as a push-button. Easy, quick and safe!

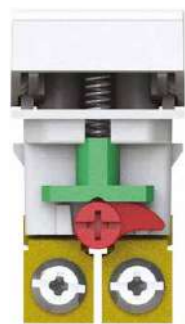

### 1. Choose

Decide whether to use Uniko as a one-way switch, two-way switch, intermediate switch or a NO/NC push-button\*.  
If you change your mind, Uniko is easy to reconfigure.

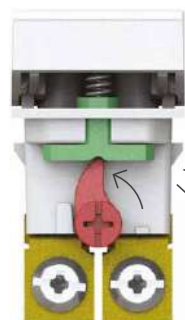

### 2. Change

Use a screwdriver to rotate the lever **upwards** to use Uniko as a push-button. Rotate the lever **downwards** to use Uniko as a rocker switch.

## Five controls in one. Select, connect, done!

The way the switch works can be determined by how it is wired.

Each switch is supplied with an instruction sheet that explains in a simple and intuitive way how to make the connections to obtain a one-way switch, push-button, two-way switch or intermediate switch.

*\*In electrical systems, there are two types of button:*

- *Normally open (NO): as soon as it is pressed, it closes the circuit.*
- *Normally closed (NC): as soon as it is pressed, it opens the circuit.*

### 1. One-way switch

A one-way switch can be used to control the switching of lamps or other appliances from a single point in the house.



## 2. Two-way switch

A two-way switch can be used to switch lights or other appliances on or off from 2 or more different points. To connect 2 different light switches to control the same light, 2 two-way switches must be used.



## 3. Intermediate switch

An intermediate switch can be used to switch lights or other appliances on or off from 3 or more different points. By using an intermediate switch together with 2 two-way switches, you can switch from 3 separate points.



## 4. Push-button

A push-button is normally used in relay circuits. The push-button is fitted with a spring mechanism, which when pressed, sends an impulse to the coil, which switches lights or other appliances on or off. Push-buttons can be used to control the load from several separate points.

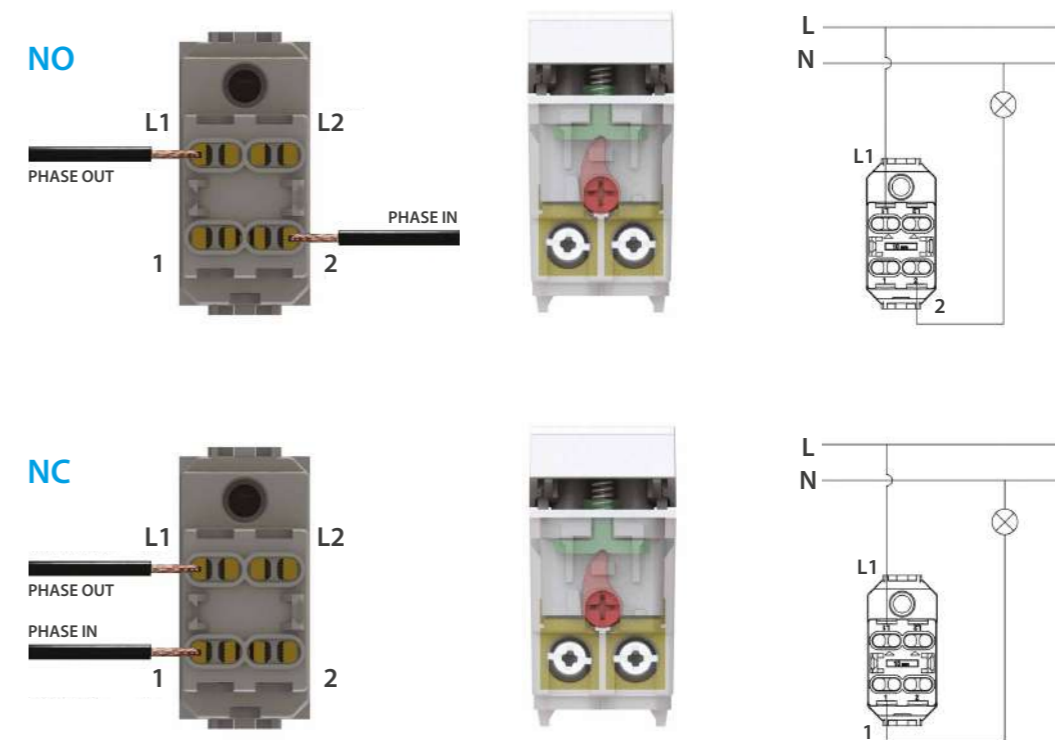

# Catalogue

More benefits  
in a single code



### Uniko applications

- One-way switch
- Two-way switch
- Intermediate switch
- NO/NC push button

### Uniko – compatible with Bticino®



4B.AM.CU  
Uniko for  
Matix™  
White



4B.N.CU  
Uniko for  
LivingLight™  
White



4B.L.CU  
Uniko for  
LivingLight™  
Anthracite



4B.NT.CU  
Uniko for  
LivingLight™  
Tech

### Uniko – compatible with Vimar®



4B.V14.CU  
Uniko for  
Plana™  
White



4B.V19B.CU  
Uniko for  
Arkè™  
White



4B.V19.CU  
Uniko for  
Arkè™  
Grey



4B.V19M.CU  
Uniko for  
Arkè™  
Metal

### Uniko – compatible with Gewiss®



4B.G20.CU  
Uniko for  
System™  
White





## U SERIES

Electrical systems are **evolving** due to the use of flush-mounted USB power supplies for residential and commercial wiring accessory systems. 4box, with the widest range of products on the market, offers its customers a variety of solutions.

**U SERIES** products ensure maximum charging speed in the smallest possible space, eliminating the need for external power supplies.

**Perfectly matched looks** and functional **compatibility** with the main residential and commercial wiring accessory systems from Bticino®, Vimar® and Gewiss®, and designed according to the latest technological standards to ensure that all devices are correctly powered and charged in the shortest possible time.

**U SERIES. Good looks and maximum charging speed for your devices.**



4b USB 2.1 2.4



4b USB CA 20W



4b USB CCA 20W



4b USBP40 3.0



4b USBP503





# 4b USB 2.1 2.4

Change the way you think about electrical sockets. USB 2.1 and 2.4 are the 4box single-module USB sockets with maximum output loads of 2.1 and 2.4 A respectively. Ideal for the for fast charging of smartphones, tablets and other devices, without having to use power supplies.



## Highlights

- 2.1 A and 2.4 A
- Perfectly matched with the most popular residential and commercial wiring accessory systems
- Charge your devices without using power supplies
- Competitively priced
- Fitted with a USB type A socket, or 2 additional USB type A sockets in a single module (USB 2.4)
- Small Only 47 mm deep

## The fastest and most powerful range of USB power supplies in a single module

Maximum power, perfectly matched looks and minimum space requirements are the winning features of these products, whose quality has been certified by IMQ laboratories and awarded the relevant mark.



## Compatible with the most popular residential and commercial wiring accessory systems

**Bticino**<sup>®</sup>  
Matix<sup>™</sup>, LivingLight<sup>™</sup>, Axolute<sup>™</sup>

**Vimar**<sup>®</sup>  
Plana<sup>™</sup>, Arkè<sup>™</sup>

**Gewiss**<sup>®</sup>  
Chorus<sup>™</sup>

## Easier

**Simplification:** The device can be connected directly to the USB 2.1 and 2.4 sockets without the need for power supplies.

## More options

**Customizable:** Create your own combinations thanks to the devices' modularity. Can be combined freely with a bipasso plug, Side module or a blanking plate.



# Catalogue

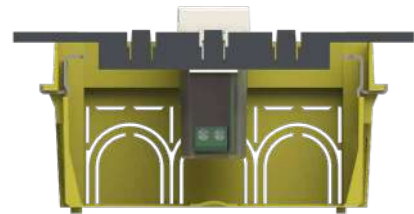

## Small size, huge advantage

The small size of the USB socket means there is plenty of room for cable routing (1.2 cm to 1.5 cm from the bottom of the box depending on the model).

### Compatible with

#### USB 2.1

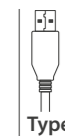

#### USB 2.4

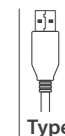

### Compatible with Bticino®

#### 4b USB 2.1



**4B.AM.USB**  
USB 2.1 for  
**Matix™**  
White

#### 4b USB 2.4



**4B.AM.USB.24**  
USB 2.4 for  
**Matix™**  
White



**4B.N.USB**  
USB 2.1 for  
**LivingLight™**  
White



**4B.N.USB.24**  
USB 2.4 for  
**LivingLight™**  
White



**4B.L.USB**  
USB 2.1 for  
**LivingLight™**  
Anthracite



**4B.L.USB.24**  
USB 2.4 for  
**LivingLight™**  
Anthracite



**4B.NT.USB**  
USB 2.1 for  
**LivingLight™**  
Tech



**4B.NT.USB.24**  
USB 2.4 for  
**LivingLight™**  
Tech



**4B.HD.USB**  
USB 2.1 for  
**Axolute™**  
White

### Compatible with Gewiss®

#### 4b USB 2.1



**4B.G12.USB**  
USB 2.1 for  
**Chorus™**  
Black

#### 4b USB 2.4



**4B.G10.USB.24**  
USB 2.4 for  
**Chorus™**  
White

### Compatible with Vimar®

#### 4b USB 2.1



**4B.V14.USB**  
USB 2.1 for  
**Plana™**  
White

#### 4b USB 2.4



**4B.V14.USB.24**  
USB 2.4 for  
**Plana™**  
White



**4B.V19B.USB.24**  
USB 2.4 for  
**Arke™**  
White



**4B.V19.USB.24**  
USB 2.4 for  
**Arke™**  
Grey



**4B.V19M.USB.24**  
USB 2.4 for  
**Arke™**  
Metal



# 4b USB CA 20W

4box has recently added new additions to its single-module USB range. USB CA 20W is a USB socket with a 20 W output that can rapidly charge your devices thanks to Fast Charge technology and Power Delivery protocol.



## Highlights

- 20 W. Fast charge** technology with Power Delivery protocol
- Perfectly matched** with the most popular residential and commercial wiring accessory systems
- Charge your devices **without using power supplies**
- Competitively priced**
- Fitted with a **USB type A socket** and a **USB type C socket in a single module**
- Small** Only 47 mm deep

## The new faster and more powerful USB power supplies

USB CA 20W is the module with a **USB C Power Delivery** and a **USB A Fast Charge**, that brings you safe, super-fast charging for your devices.



## The quality of excellence

Maximum power, perfectly matched looks and minimum space requirements are the winning features of these products, whose quality has been certified by IMQ laboratories and awarded the relevant mark.



## Compatible with the most popular residential and commercial wiring accessory systems

**Bticino**<sup>®</sup>  
Matix<sup>™</sup>, LivingLight<sup>™</sup>, Axolute<sup>™</sup>, LivingNow<sup>™</sup>

**Vimar**<sup>®</sup>  
Plana<sup>™</sup>, Arkè<sup>™</sup>

**Gewiss**<sup>®</sup>  
Chorus<sup>™</sup>

## Faster

**Fast Charge** is a technology that allows battery-powered devices to be charged with **more power** than the typical 5 W and 2 A of most USB standards. It allows the device's battery to be **recharged faster** by acting on a charger's amperage and voltage, so as to **increase the battery's absorption capacity**.

## Safer

**Power Delivery** is a charging protocol via **USB C** that delivers **more power, faster and more safely** than standard chargers. With **Power Delivery** you can charge your device up to **70% faster** than with standard chargers.



# Catalogue

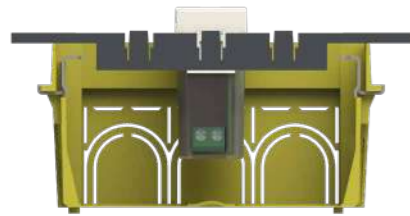

## Small size, huge advantage

The small size of the USB CA socket means there is plenty of room for cable routing (1.2 cm to 1.5 cm from the bottom of the box depending on the model).

### Compatible with

USB

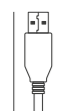

Type A

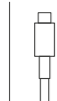

Type C

### USB CA 20W – compatible with Bticino®



**4B.AM.USB.30**  
USB CA 20W  
for **Matix™**  
White



**4B.N.USB.30**  
USB CA 20W  
for **LivingLight™**  
White



**4B.L.USB.30**  
USB CA 20W  
for **LivingLight™**  
Anthracite



**4B.NT.USB.30**  
USB CA 20W  
for **LivingLight™**  
Tech



**4B.HD.USB.30**  
USB 3.0A  
for **Axolute™**  
White



**4B.HS.USB.30**  
USB 3.0A  
for **Axolute™**  
Anthracite



**4B.HC.USB.30**  
USB 3.0A  
for **Axolute™**  
Tech



**4B.K.USB.30**  
USB CA 20W  
for **LivingNow™**  
3 front plates supplied

### USB CA 20W – compatible with Vimar®



**4B.V14.USB.30**  
USB CA 20W  
for **Plana™**  
White



**4B.V19B.USB.30**  
USB CA 20W  
for **Arkè™**  
White



**4B.V19.USB.30**  
USB CA 20W  
for **Arkè™**  
Grey



**4B.V19M.USB.30**  
USB 3.0A  
for **Arkè™**  
Metal

### USB CA 20W – compatible with Gewiss®



**4B.G10.USB.30**  
USB 3.0 A  
for **Chorus™**  
White



**4B.G12.USB.30**  
USB 3.0 A  
for **Chorus™**  
Black

# 4b USB CCA 20W

The most complete solution for USB charging in a single module. The CCA 20W USB socket quickly charges devices, is versatile and provides maximum safety.



## Highlights

- 20 W. Fast charge** technology with Power Delivery protocol
- Perfectly matched** with the most popular residential and commercial wiring accessory systems
- Charge your devices **without using power supplies**
- Competitively priced**
- Fitted with a **USB type A socket** and two **USB type C socket in a single module**
- Small** Only 47 mm deep

## More inputs. Faster charging

USB CCA 20W boasts two USB C Power Delivery ports and one USB A Fast Charge port, providing maximum charging speed and application flexibility.



## Certified quality

IMQ certification guarantees the quality of these devices.



## Compatible with the most popular residential and commercial wiring accessory systems

**Bticino®**  
Matix™, LivingLight™, LivingNow™

**Vimar®**  
Plana™, Arkè™, Linea™

## Faster

**Fast Charge** is a technology that allows battery-powered devices to be charged with **more power** than the typical 5 W and 2 A of most USB standards. It allows the device's battery to be **recharged faster** by acting on a charger's amperage and voltage, so as to **increase the battery's absorption capacity**.

## Safer

**Power Delivery** is a charging protocol via USB C that delivers **more power, faster and more safety** than standard chargers. With **Power Delivery** you can charge your device up to **70% faster** than with standard chargers.





# Catalogue

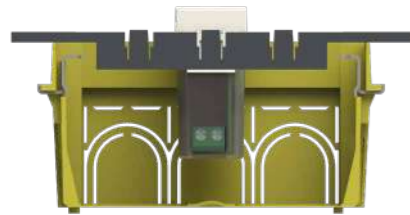

For almost **all your needs**. Locate it **wherever you wish**.

Easy and flexible installation thanks to the ample space available for cable routing.

## Compatible with

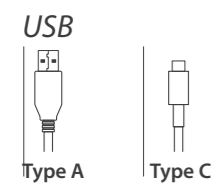

### USB CCA 20W – compatible with Bticino®



4USB20WCCA.AM  
USB CCA 20W  
for **Matix™**  
White



4USB20WCCA.N  
USB CCA 20W  
for **LivingLight™**  
White



4USB20WCCA.L  
USB CCA 20W  
for **LivingLight™**  
Anthracite



4USB20WCCA.NT  
USB CCA 20W  
for **LivingLight™**  
Tech



4USB20WCCA.K  
USB CCA 20W  
for **LivingNow™**  
3 front plates supplied

### USB CCA 20W – compatible with Vimar®



4USB20WCCA.V14  
USB CCA 20W  
for **Plana™**  
White



4USB20WCCA.V19B  
USB CCA 20W  
for **Arkè™**  
White



4USB20WCCA.V19  
USB CCA 20W  
for **Arkè™**  
Grey



4USB20WCCA.V30  
USB CCA 20W  
for **Linea™**  
3 front plates supplied

# 4b USBP40 3.0

More than just a multifunctional socket. USBP40 3.0 is the socket that integrates a P40 and a 3 A USB type C power supply in just 2 modules. The new 4box electrical outlet ensures simultaneous use and fast charging.



## P40 socket and 3 A USB power supply integrated in just 2 modules

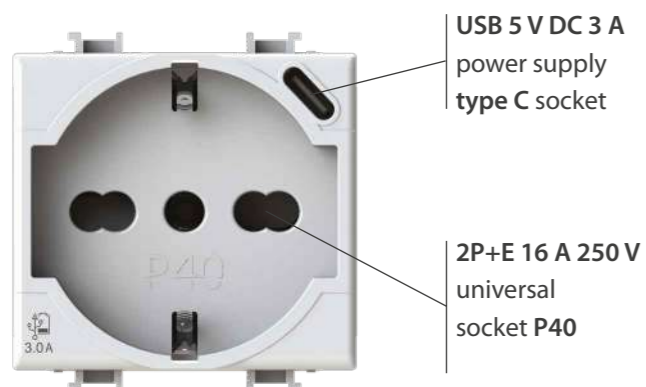

**Compatible** with the most popular residential and commercial wiring accessory systems

Bticino®  
Matix™, LivingLight™, LivingNow™

Vimar®  
Plana™, Arkè™

## Highlights

- Maximum power and recharge speed**
- Fitted with a 3 A USB type C socket**
- Compatible** with the most popular residential and commercial wiring accessory systems
- USBP40 3.0 is patented**
- No need for adaptors or power supplies**

## Faster

The USB power supply can deliver up to **3 A**, ensuring **maximum charging speed**. The **type C** outlet allows devices such as **laptops** to be powered and charged **without the use of power supplies**.

## Modern

USBP40 3.0 powers both the traditional **type P40** socket and the **USB power supply** at the same time.

## Widely compatible

USBP40 3.0 is **compatible** with the **leading residential and commercial wiring accessory systems** on the market, satisfying the tastes and choices of even the most demanding customers.



## 4box reinvents the concept of the electrical socket

4box has integrated a 3 A USB power supply into a P40 socket to meet the needs of modern electrical systems that satisfy even the most demanding customers. USBP40 3.0 is patented.

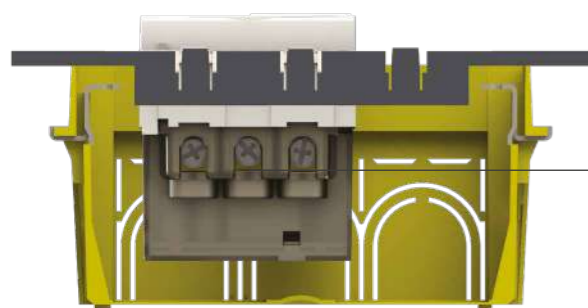

- A single power supply terminal makes wiring quick and easy
- The space available for cable routing from the bottom is between 0.7 cm and 1 cm depending on the model

### For the installer:

USBP40 3.0 is a new selling point for installers, who have the opportunity to offer the customer a new solution to improve their electrical system.

### For the distributor:

USBP40 3.0 gives distributors the opportunity to innovate their product range, offering a unique product to their customers.

### For the end customer:

No more worries about charging! With USBP40 3.0, you always have the fastest, most powerful power supply available to power and charge all your devices.

## Do you have a USB type A connector? No problem!

4box provides a free type C to type A adaptor with every socket. This means that those who do not yet have a type C connector on their device can use the built-in USB power supply straight away.



## Catalogue

### USBP40 3.0 – compatible with Bticino®



4B.AM.P40.USB  
USBP40 3.0  
for Matix™  
White



4B.V14.P40.USB  
USBP40 3.0  
for Plana™  
White



4B.N.P40.USB  
USBP40 3.0  
for LivingLight™  
White



4B.L.P40.USB  
USBP40 3.0  
for LivingLight™  
Anthracite



4B.NT.P40.USB  
USBP40 3.0  
for LivingLight™  
Tech



4B.V19B.P40.USB  
USBP40 3.0  
for Arkè™  
White



4B.V19.P40.USB  
USBP40 3.0  
for Arkè™  
Grey



4B.V19M.P40.USB  
USBP40 3.0  
for Arkè™  
Metal



4B.KW.P40.USB  
USBP40 3.0  
for LivingNow™  
White



4B.KG.P40.USB  
USBP40 3.0  
for LivingNow™  
Anthracite



4B.KM.P40.USB  
USBP40 3.0  
for LivingNow™  
Sand

### Plugs compatible with USBP40 3.0

#### Italian standard

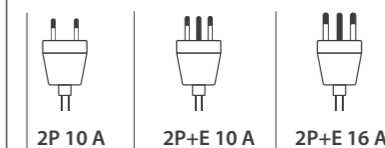

#### German standard





# 4b USBP503

USBP503 is the first universal recessed charging point. With 5 electrical sockets, 2 USB type C outputs and a single wiring terminal, it represents the ultimate in 4box-branded versatility and simplicity.



USBP503 lets you to use up to **5 sockets simultaneously** – in just **3 modules!**

USBP503 is the compact, flush-mounted multi-socket designed to optimize space. 5 different electrical sockets and 2 USB type C outputs in one device, that can be installed in a traditional 3-module 503 box.

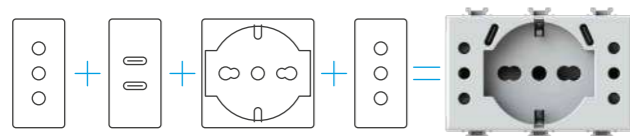

**Compatible** with the most popular residential and commercial wiring accessory systems

Bticino®  
Matix™, LivingLight™, LivingNow™

Vimar®  
Plana™, Arke™

## Highlights

- Maximum power and recharge speed**
- Competitively priced**
- Compatible** with the most popular residential and commercial wiring accessory systems
- Fitted with two 3 A USB type C socket**
- No need for adaptors or power supplies**
- USBP503 is patented**

## More versatile

5 different sockets to suit every need, so you can finally say goodbye to adaptors and power supplies.

## Safer

With its internal temperature sensor and self-learning memory, the USBP503 prevents overheating of connected devices.

## Universal

The first truly universal flush-mounted charging station.



## The new standard in electrical sockets



### 1. No more adaptors

With USBP503, you can connect devices fitted with Schuko and USB type C connectors without the need for adaptors or power supplies.

### 2. Saves space

With USBP503, you can use five plugs at the same time in a single three-module socket.

### A single power supply terminal

USBP503 is fitted with a single terminal block for quick and easy installation.

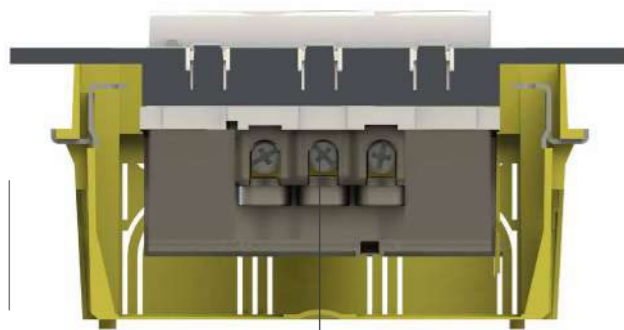

- A single power terminal block makes wiring quick and easy.
- The space available for cable routing from the bottom is between 1 cm and 1.3 cm depending on the box model.

### Did you know that...

In 2024, the USB C connector will become the new European standard for charging devices, establishing a single charging solution for electronic devices such as:

- Laptops
- Tablets
- Smartphones
- Smart watches
- True wireless headphones
- E-readers
- Digital cameras
- Portable gaming consoles
- Portable loudspeakers

In addition, the USB C standard is already present in many other electronic devices.

## Catalogue

### USBP503 – compatible with Bticino®



4BUSBP503.AM  
USBP503 for Matix™  
White



4BUSBP503.L  
USBP503 for LivingLight™  
Anthracite



4BUSBP503.N  
USBP503 for LivingLight™  
White



4BUSBP503.NT  
USBP503 for LivingLight™  
Tech

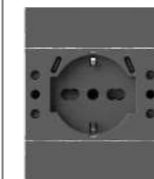

4BUSBP503.KG  
USBP503 for LivingNow™  
Black



4BUSBP503.KM  
USBP503 for LivingNow™  
Sand



4BUSBP503.KW  
USBP503 for LivingNow™  
White

### USBP503 – compatible with Vimar®



4BUSBP503.V14  
USBP503 for Plana™  
White



4BUSBP503.V19  
USBP503 for Arkè™  
Grey



4BUSBP503.V19B  
USBP503 for Arkè™  
White



4BUSBP503.V19M  
USBP503 for Arkè™  
Metal

### Plugs compatible with USBP503

#### Italian standard

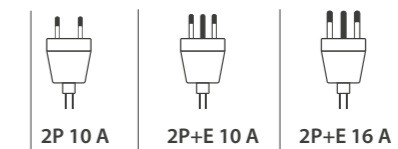

#### German standard

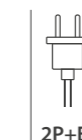

#### USB

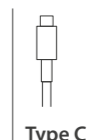

Designed by 4box, product manufactured under licence by AVE S.p.A.





# B SERIES

4box offers a number of complementary devices that are **essential** for creating an electrical system that can be used with various wiring accessory products around the home. These include socket frames and blanking plates – products that may be simple accessories, but ones for which 4box has nevertheless developed **innovations**. **Libero** is the multi-series frame that revolutionizes the way in which wiring accessories are installed. You can choose finishes and cover plates from other Series and systems for a total customization of the look of your installation. **Titappo** is the world's first and only blanking plate fitted with **Stripper**, an ingenious 4box patent that lets you strip the wires without tools.

**B SERIES. Simple devices for a modern and innovative system.**



4b Libero

NEW



4b Cover Plates

NEW



4b Bundle



4b Hide



4b Titappo





# 4b Libero

Until now, for every wiring accessory system, there was only one frame on which the relative cover plates and modules could be installed. With Libero, you can choose finishes from other ranges and other brands, allowing you the freedom to create a complete customization.

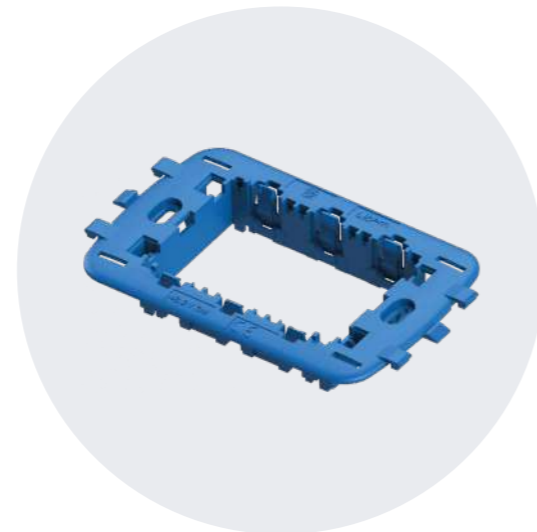

The **unique mounting frame** that **revolutionizes** the installation of the **most popular** residential and commercial wiring accessory systems

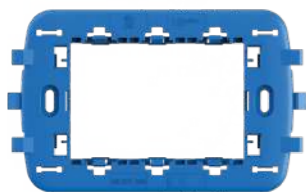

**Compatible with the following systems:**

**Bticino®**  
LivingLight™

**Vimar®**  
Eikon™, Arkè™, Plana™

**Compatible with the following cover plates:**

**Bticino®**  
LivingLight™ quadra (not Air),  
LivingInternational™, Axolute™ only 3 modules (not Air)

**Vimar®**  
Plana™, Arkè™ (not Fit), Eikon™

## Highlights

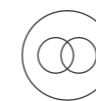

**Compatible** with the most popular residential and commercial wiring accessory systems



**Competitively priced**



An exceptionally wide **endless choice of 'look'**



For 2, 3, 4 or 7 module cover plates

## Freedom for you

You can choose from the look and functions offered by the leading manufacturers of residential and commercial wiring accessory systems, **without having to use their frame.**

## Versatile

With Libero you can **change the cover plate** of residential and commercial wiring accessory systems **without having to do invasive and expensive work.** Changing the look of your living space has never been **easier.**

## Widely compatible

The Libero support is **compatible** with modules, functions and plates offered by manufacturers, allowing you to **combine quality and personal taste.**

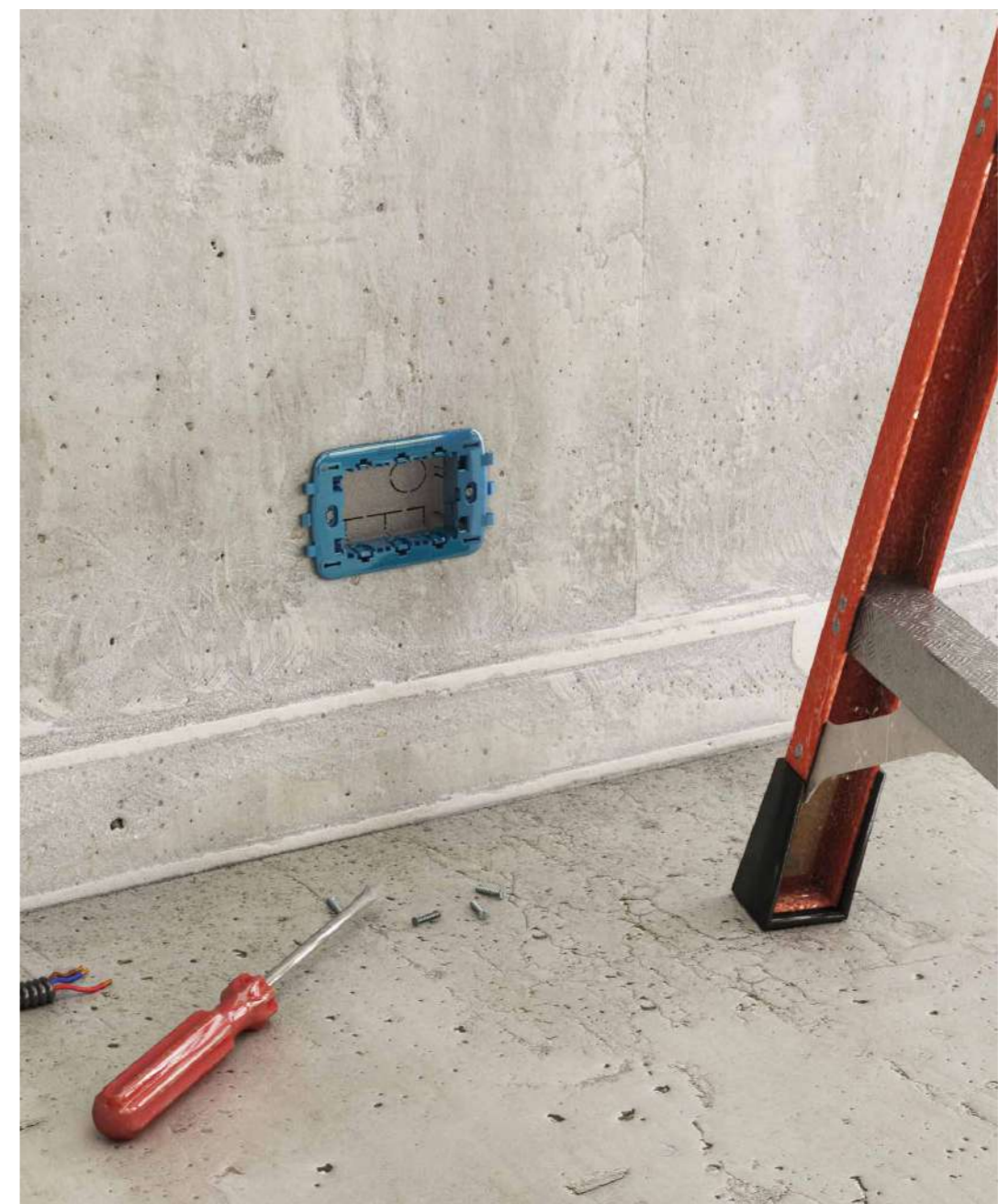

## A simple solution full of advantages

A unique and original mounting frame that lets you install the modules, functions and cover plates of the most popular residential and commercial wiring accessory systems. With Libero from 4box, **you are no longer limited by a lack of choice** or time constraints. Change the look of your home when you want and however you want.

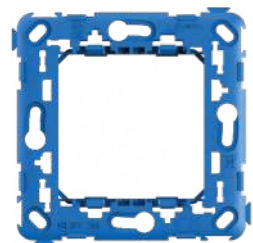

Libero – two modules

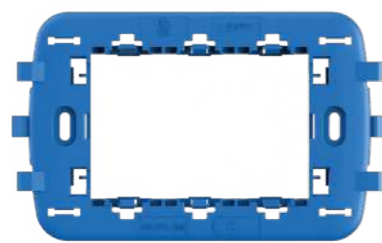

Libero – three modules



Libero – four modules



Libero – seven modules

### For the installer:

The choice of frame **does not limit the final choice** of finish, optimizing work time and giving the customer more time to decide.

### For the distributor:

Having a **single code** for different frames lets you optimize your inventory and market your products more **efficiently**.

### For the end customer:

For the first time, you are free to **choose cover plates and modules from different manufacturers** to create your own original and customized solution.

## All for one, one for all

Libero gives you the opportunity to **change the look** of your wiring accessories, and much more. By associating Libero with 4box devices, **thanks to their versatility and their compatibility** with the most popular residential and commercial wiring accessory systems, you can change the look of your living space simply and effectively. **Changing the look has never been easier.**

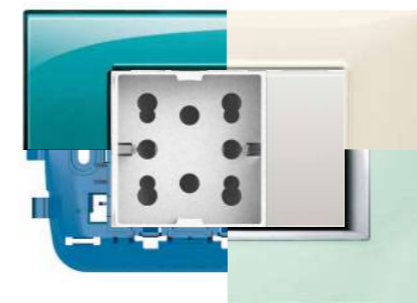

## Use with Bticino® Living™ International cover plates

In order to use the Libero support with Bticino® Living™ International cover plates it is necessary to **remove the tabs** shown in the picture.

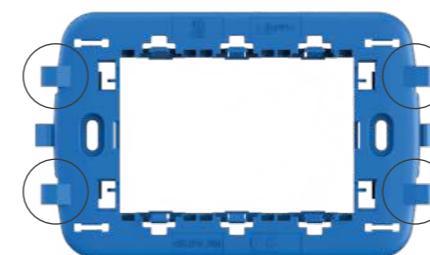

## Catalogue

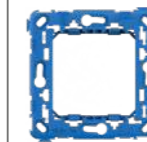

**4B.BV.2M**  
Libero for  
Bticino® and Vimar®  
2 modules



**4B.BV.3M**  
Libero for  
Bticino® and Vimar®  
3 modules



**4B.BV.4M**  
Libero for  
Bticino® and Vimar®  
4 modules



**4B.BV.7M**  
Libero for  
Bticino® and Vimar®  
7 modules



# 4b Cover Plates

Interchangeable wiring accessory cover plates are an important decorative feature of your home. With their simple lines and neutral colours, these new additions look great in almost any setting, whether residential or commercial.

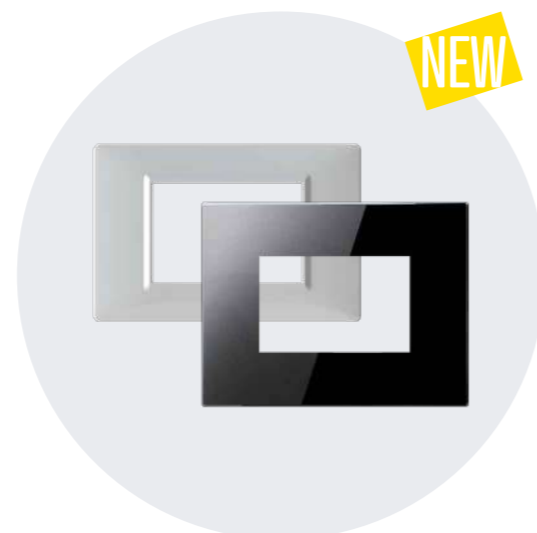

Having the option of using wiring accessories with **2, 3, 4 and 7 modules** widens your choice, and increases the number of **different functions** you can use for your application.

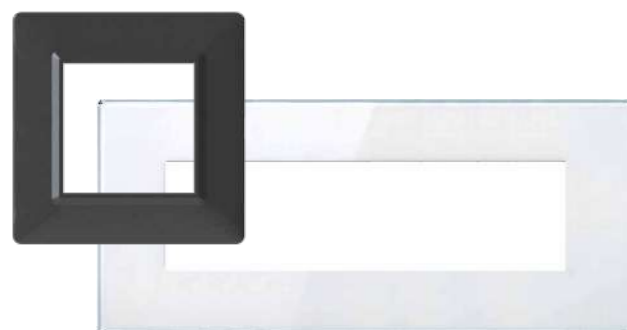

**Compatible with the following frames:**

- 4box  
Libero
- Bticino®  
Matix™
- Vimar®  
Plana™, Arkè™, Eikon™

## Highlights

- Neutral look suitable for most living spaces
- Competitively priced
- Compatible with the most popular residential and commercial wiring accessory systems
- Different materials, different look to suit almost any environment

## Widely compatible

Depending on the model, 4box top plates can be used with the most popular residential and commercial wiring accessory systems, including: Bticino® Matix™, Vimar® Plana™, Arkè™ and Eikon™, as well as with 4box's own Libero.

## Cost-effective

By using technopolymer and methacrylate, these top plates are both cost-effective and 'affordable'.

## Tough

Methacrylate itself is crystal clear. Being significantly lighter and much stronger, it is often used as an alternative to glass.





## Methacrylate and technopolymer for the best look

These two low-cost materials look fabulous. Methacrylate has an amazing glass-like effect, and technopolymer looks great in almost any setting.

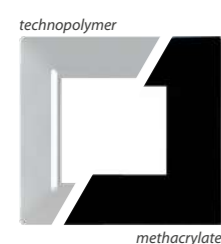

2 module cover plate

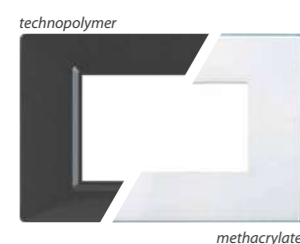

3 module cover plate

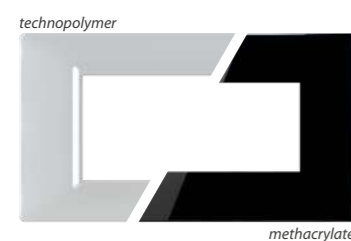

4 module cover plate

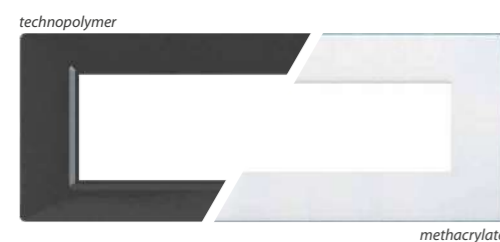

6-7 module cover plate

## Catalogue

### Cover plate – compatible with Bticino® Methacrylate



4B.BG.2M.BN  
2 module cover plate  
for Matix™  
White



4B.BG.2M.NR  
2 module cover plate  
for Matix™  
Black



4B.BG.3M.BN  
3 module cover plate  
for Matix™  
White



4B.BG.3M.NR  
3 module cover plate  
for Matix™  
Black



4B.BG.4M.BN  
4 module cover plate  
for Matix™  
White



4B.BG.4M.NR  
4 module cover plate  
for Matix™  
Black



4B.BG.6M.BN  
6 module cover plate  
for Matix™  
White



4B.BG.6M.NR  
6 module cover plate  
for Matix™  
Black

### Cover plate – compatible with Vimar® Methacrylate



4B.BV.2M.BN  
2 module cover plate  
for Plana™, Arkè™,  
Eikon™ and 4box Libero  
White



4B.BV.2M.NR  
2 module cover plate  
for Plana™, Arkè™,  
Eikon™ and 4box Libero  
Black



4B.BV.3M.BN  
3 module cover plate  
for Plana™, Arkè™,  
Eikon™ and 4box Libero  
White



4B.BV.3M.NR  
3 module cover plate  
for Plana™, Arkè™,  
Eikon™ and 4box Libero  
Black



4B.BV.4M.BN  
4 module cover plate  
for Plana™, Arkè™,  
Eikon™ and 4box Libero  
White



4B.BV.4M.NR  
4 module cover plate  
for Plana™, Arkè™,  
Eikon™ and 4box Libero  
Black



4B.BV.6M.BN  
7 module cover plate  
for Plana™, Arkè™,  
Eikon™ and 4box Libero  
White



4B.BV.6M.NR  
7 module cover plate  
for Plana™, Arkè™,  
Eikon™ and 4box Libero  
Black

### Cover plate – compatible with Vimar® Technopolymer



4B2MBN.V14  
2 module cover plate  
for Plana™  
and 4box Libero  
White



4B2MAN.V14  
2 module cover plate  
for Plana™  
and 4box Libero  
Anthracite



4B3MBN.V14  
3 module cover plate  
for Plana™  
and 4box Libero  
White



4B3MAN.V14  
3 module cover plate  
for Plana™  
and 4box Libero  
Anthracite



4B4MBN.V14  
4 module cover plate  
for Plana™  
and 4box Libero  
White



4B4MAN.V14  
4 module cover plate  
for Plana™  
and 4box Libero  
Anthracite



4B7MBN.V14  
7 module cover plate  
for Plana™  
and 4box Libero  
White



4B7MAN.V14  
7 module cover plate  
for Plana™  
and 4box Libero  
Anthracite

# 4b Bundle

4box offers a combination of different products to provide a complete, ready-to-use bundle. The new Cover Plate, combined with Libero frame and the multi-standard P503 and USBP503 sockets provide a good looking, functional solution.



Do you need to **add** or **replace** an electrical socket in your home?

**4box Bundle is the answer!**  
The look of the products match almost all pre-existing installations, and the multi-standard P503 and USBP503 sockets, with their wealth of features, are the perfect combination.



## Highlights

- 1

A ready-to-use solution
- 0  
0  
0

A ready-to-use solution for **replacing** or **adding** an electrical socket
- €

**Competitively priced**
- Screw icon

Single terminal for **quick and easy installation**

## Catalogue



**4BP503KIT.BN**  
Bundle with P503, Libero frame and Cover Plate – White



**4BP503KIT.AN**  
Bundle with P503, Libero frame and Cover Plate – Anthracite



**4BUSBP503KIT.BN**  
Bundle with USBP503, Libero frame and Cover Plate – White



**4BUSBP503KIT.AN**  
Bundle with USBP503, Libero frame and Cover Plate – Anthracite

# 4b Hide

Hide revolutionizes the concept of the electrical socket. The plug disappears inside the wall, behind the sliding cover, leaving the wall neat and uncluttered. Hide is very simple to use. Just slide the front panel, insert the plug and, that's it. You can camouflage Hide on your wall with a choice of different cover materials.

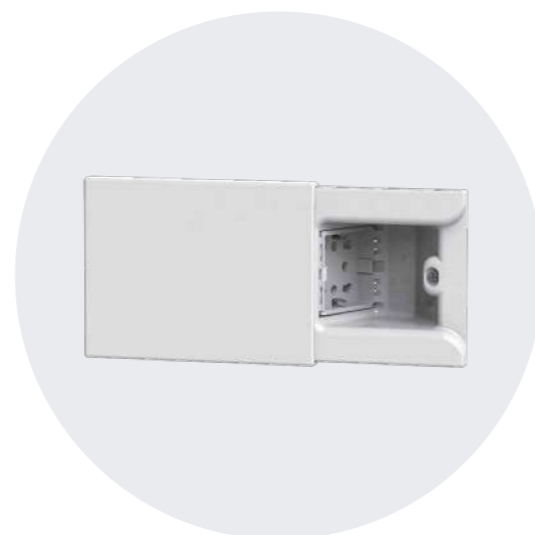

## Can be installed within existing back boxes

Hide can be installed just like a conventional socket. Installation can be in 3- or 4-module flush-mounted boxes without the need for adaptors. There are no special wiring requirements.



## Simply brilliant





Hide does not just mean style. It also means **functionality and ease of installation**. When designing the socket outlet that **revolutionized the electrical market**, 4box also thought about ease of installation. Hide is **compatible with existing boxes and wiring**. Hide never ceases to amaze: **an idea of the present, projected into the future**.

## The intuition that makes the difference

Hide is the result of a collaboration between 4box and Italy Innovations.



## Highlights

-  **A wide range available, according to your needs**
-  **Customizable, from finishes available on the market, to DIY**
-  **Installation in 3- or 4-module flush-mounted boxes**
-  **Child safe with sliding door closure**
-  **Protrudes only 11 mm from the wall with the plug inserted**







### Attractive

**Minimal:** A fine, linear design that reflects an evolved, innovative and personal approach.

**Evolved:** Turns an electrical outlet into a original accessory that helps to keep things tidy.



### Functional

**Frees up space:** It allows you to position furniture close to sockets without the annoyance of a plug.

**Compact:** It protrudes only 11 mm from the wall when the plug is inserted, ensuring a low visual impact. Cable clutter is no longer an issue.



### Customizable

**Customizable:** Hide can be painted or decorated with wall coverings, wallpaper or screen prints. You can let your imagination run wild.

**Multi-material:** the ABS plastic door can be clad in glass, wood, metal, marble and other materials of your choice for maximum freedom of design.



### Safe

**Protected:** No visible plugs mean greater safety for children.

**Intuitive:** Extremely easy to install and use.

### Would you like to use your own sockets?

If so, you can order frame-only versions of Hide, which you can use with the Vimar® Plana™ Series sockets.

Sockets with French, German, Swiss, U.S., Israeli, Argentine and Euro-American standards are also available upon request.

## Catalogue

### Hide – 3 and 4 modules



4B.01.000  
Frame only  
3 modules  
White



4B.01.014  
2 bipasso sockets  
3 modules  
White



4B.01.015  
With P40  
3 moduli  
White



4B.01.H21  
With Side  
3 modules  
White



4B.04.000  
Frame only  
4 modules  
White



4B.01.014  
2 bipasso sockets  
3 modules  
White



4B.04.015  
With P40  
4 modules  
White



4B.04.H21  
With Side  
4 modules  
White



4B.03.H21  
With Side  
3 modules  
Anthracite

Hide was designed by Italy Innovazioni.



# 4b Titappo

Titappo is the world's only blanking plate supplied with Stripper. This innovative technology allows you to strip wires of two different diameters (1.5 mm<sup>2</sup> and 2.5 mm<sup>2</sup>) without tools. With Titappo, your installation is ready to go.

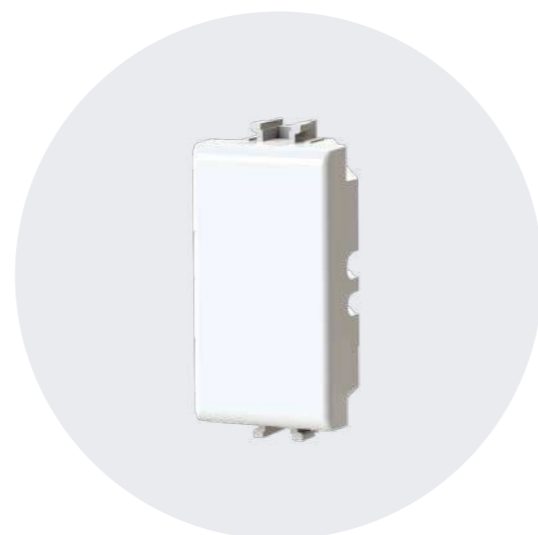

## Highlights

- Compatible** with the most popular residential and commercial wiring accessory systems
- No more tools!**  
Built-in wire stripper

- Competitively priced**
- Quick and easy** to install

## The first blanking plate with built-in wire Stripper

With Titappo and Stripper, a fantastic new 4box patent, your installation is ready to go.



## Compatible with the most popular residential and commercial wiring accessory systems

**Bticino**<sup>®</sup>  
Matix<sup>™</sup>, LivingLight<sup>™</sup>

**Vimar**<sup>®</sup>  
Plana<sup>™</sup>, Arkè<sup>™</sup>

**Gewiss**<sup>®</sup>  
System<sup>™</sup>

## Catalogue

### Titappo – compatible with Bticino<sup>®</sup>



4B.AM.TT  
Titappo for  
Matix<sup>™</sup>  
White



4B.N.TT  
Titappo for  
LivingLight<sup>™</sup>  
White



4B.L.TT  
Titappo for  
LivingLight<sup>™</sup>  
Anthracite



4B.NT.TT  
Titappo for  
LivingLight<sup>™</sup>  
Tech

### Titappo – compatible with Vimar<sup>®</sup>



4B.V14.TT  
Titappo for  
Plana<sup>™</sup>  
White



4B.V19B.TT  
Titappo for  
Arkè<sup>™</sup>  
White



4B.V19.TT  
Titappo for  
Arkè<sup>™</sup>  
Grey



4B.V19M.TT  
Titappo for  
Arkè<sup>™</sup>  
Metal

### Titappo – compatible with Gewiss<sup>®</sup>



4B.G20.TT  
Titappo for  
System<sup>™</sup>  
White



# E SERIES

With 4box, your electrical system can be enhanced with **unique solutions** that increase efficiency and practicality by making certain everyday tasks, such as inserting an electrical plug into a socket or switching on a light, simpler and more functional. Whether indoors or outdoors, 4box's **E SERIES** products meet the needs of everyday life by adding value to your electrical system.

**E SERIES. Simple ideas that enhance your home.**



4b Wide



4b Externa IP40



4b Externa IP55





# 4b Wide

Wide is the only enclosure in the world that retains its IP55 protection rating even with the plug connected when installed in its 3-module flush-mounted box. What's more, it retains IP66 protection when mounted in its wall-mounted enclosure.

Wide takes the ingenious idea of Hide and adds a protection system against contact with solids and liquids. No other solution in the world can match this performance.



## Advanced safety

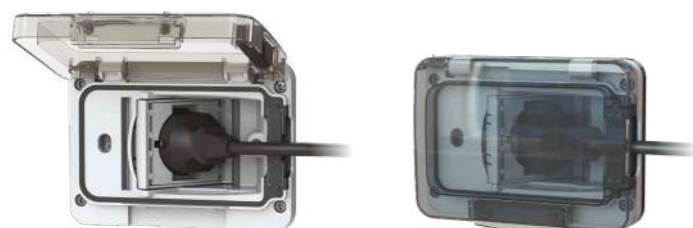

## Protection rating

IP55  
With flush-mounted box

IP66  
With wall-mounted enclosure

## Compatible with the following residential and commercial wiring accessory systems:

Vimar®  
Plana™ (in the Wide frame only version)

## Highlights



A wide range available, according to your needs



Protection rating IP55 and IP66



Installation in 3-module boxes



Versatile. Can also be used with Schuko 90° plugs

## Waterproof

Its unique support, means that **Wide is waterproof even with the plug connected**, maintaining its IP55 or IP66 rating.

## Attractive

Wide's elegant design means that it can be **installed in both residential settings**, such as balconies and gardens, and in tertiary/industrial settings.

## Complete

With Wide, you can use the most common types of plugs available on the Italian market.



## Wide. One of the **safest** and **most versatile** electrical sockets available today

The tiltable electrical outlet can be used with many of the most common types of plug, including the **Schuko plug with a 90° cable outlet**. The pressure exerted when inserting the plug is sufficient to carry out the movement. Wide guarantees the protection of the system and retains its **IP55** protection rating even with the plug connected when installed in its three-module flush-mounted box. What's more, it retains **IP66** protection when mounted in its wall-mounted enclosure. **Wide is compatible with a wide range of commercially available plugs.**



## The only socket for 3-module boxes that is **waterproof, even with the plug connected**

**No need to unplug in bad weather**, as the protection level is maintained. Wide is the only 3-module outdoor flush-mounted socket outlet that can **guarantee** this kind of **performance**. Suitable for use in the home, outdoors, **swimming pools** and **garages**, and excellent in working environments, from **commercial kitchens** to **technical laboratories**. Whatever the application, **Wide protects your system** in complete safety.



## Wide adds **functionality** and **versatility**

The special **tilting movement** of the support on which the socket is mounted allows **many types of plugs** to be inserted, including the 90° Schuko plug.

45° tilting movement





## The high-spec. waterproof 3-module back box



### IP55 With flush-mounted box

Total protection against the ingress of solid objects.  
Protection against drips, steam, splashes and water jets.

### IP66 With wall box

Total protection against the ingress of solid objects and dust.  
Protected against powerful jets of water from any direction.

### Easy installation

Wide can be installed in standard 3-module flush-mounted boxes. This makes it perfect for new installations or refurbishments as it uses the existing box. Retrofitting existing installations is easier because the 3-module boxes that are already installed can be reused allowing work to be carried out **without having to do invasive or expensive work**. As an alternative to the 3-module IP55 flush-mounted box version, Wide is also available in an IP66 wall-mounted version.

### What does IP rating mean?

The IP (Ingress Protection) rating is a common rating used in electrical engineering to indicate the degree of protection of a device against contact with solids and liquids.

## Catalogue



**4B.W.01**  
Wide IP55  
frame only  
For 3-module  
flush-mounted box  
White

**4B.W.03**  
Wide IP55  
frame only  
For 3-module  
flush-mounted box  
Anthracite

**4B.W.RAL**  
Wide IP55  
frame only  
For 3-module  
flush-mounted box  
RAL 7035

**4B.W.CC03**  
Portable IP66  
socket with  
3 m P40 cable  
Black



**4B.W.AP**  
Pole-mounting  
Accessory for  
IP66 wall box  
RAL 7035



**4B.W.01.015**  
Wide IP55  
complete with  
bipasso Schuko socket  
for 3-module  
flush-mounted box  
White

**4B.W.03.015**  
Wide IP55  
complete with  
bipasso Schuko socket  
for 3-module  
flush-mounted box  
Anthracite

**4B.W.RAL.015**  
Wide IP55  
complete with  
bipasso Schuko socket  
for 3-module  
flush-mounted box  
RAL 7035

**4B.W.04.015**  
Wide IP55  
complete with  
bipasso Schuko socket  
for 3-module  
flush-mounted box  
Forest green



**4B.WB.01**  
IP66 wall box  
for Wide  
White

**4B.WB.03**  
IP66 wall box  
for Wide  
Anthracite

**4B.WB.RAL**  
IP66 wall box  
for Wide  
RAL 7035

**4B.WB.04**  
IP66 wall box  
for Wide  
Forest green

### Would you like to use your own modules?

If so, you can order the frame-only versions of Wide, which can be used exclusively with Vimar® Plana™ series modules.

## Accessories

### Plugs compatible with Wide

#### Italian standard

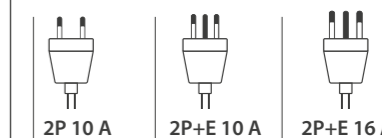

#### German Standard

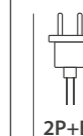



# 4b Externa IP40 IP55

Externa IP40 and IP55 are designed to offer an all-in-one solution that includes both the wall-mounted box and pre-installed module. This means faster installation times, greater cost savings and a choice to use the features of Side, Side XL, Bitappo and Uniko.



## Highlights

- all in one product
- Protection rating IP40 and IP55
- No need for adaptors
- Competitively priced
- Fast installation

## Water and dust resistant

Externa is available in IP40 and IP55 versions, which means it is protected against solid bodies larger than 1 mm (IP40), water jets and dust (IP55).

## Simple, but sophisticated

Externa IP40 and IP55 are the only all-in-one outdoor boxes. Their IP rating makes them durable and functional; the preinstalled modules make them unique and special. Side and Side XL means there is no longer any need to use an adaptor, and Uniko lets you to choose between a one-way, two-way switch, intermediate switch and push-button functions.

## Catalogue

### Externa IP40 3 modules



**4B.IP40.H21.CU**  
Externa IP40  
3 modules  
complete with  
Uniko and Side

**4B.IP40.H21.XL**  
Externa IP40  
3 modules  
complete with  
Side XL

### Externa IP55 3 modules



**4B.IP55.H21.CU**  
Externa IP55  
3 modules  
complete with  
Uniko and Side

**4B.IP55.H21.XL**  
Externa IP55  
3 modules  
complete with  
Side XL

### Externa IP40 2 modules



**4B.IP40.BT.CU**  
Externa IP40  
2 modules  
complete with  
Uniko and Bitappo

**4B.IP40.H21**  
Externa IP40  
2 modules  
complete with  
Side

### Externa IP55 2 modules



**4B.IP55.BT.CU**  
Externa IP55  
2 modules  
complete with  
Uniko and Bitappo

**4B.IP55.H21**  
Externa IP55  
2 modules  
complete with  
Side

## Find out about 4box products

Discover all the features of preinstalled modules on Externa IP40 and IP55.

- For Side see page 8*
- For Side XL see page 14*
- For Bitappo see page 24*
- For Uniko see page 30*

## Plugs compatible with Externa IP40 | IP55

### Italian standard

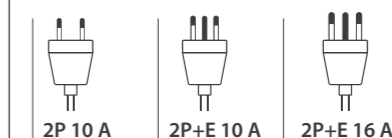

### German Standard

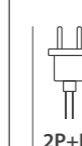



# NEW S SERIES

4box's **smart devices** are a perfect fit for almost any type of installation: renovations, refurbishments or new-builds. They are super easy to install and **require no gateway**. The S SERIES is based on Wi-Fi communication protocol, integrated into all 4box smart devices.

The product range includes:

- **P40 S**, a class-leading electrical socket from 4box
- **Uniko Lite S**, the 4box smart switch for controlling 1-way, two-way and intermediate switched circuits
- **Uniko Pro S**, the world's only multifunctional smart control for lights and shutters
- **Relè Lite S e Relè Pro S**, relays capable of making any system smart.

All S SERIES devices are compatible with Google Home and Amazon Alexa.

**S SERIES is compatible** with the most popular residential and commercial wiring accessory systems: Bticino® LivingLight™, LivingNow™ and Matix™; Vimar® Plana™ and Arké™.



4b P40 S



4b Uniko Lite S



4b Uniko Pro S



4b Relè Lite S



4b Relè Pro S

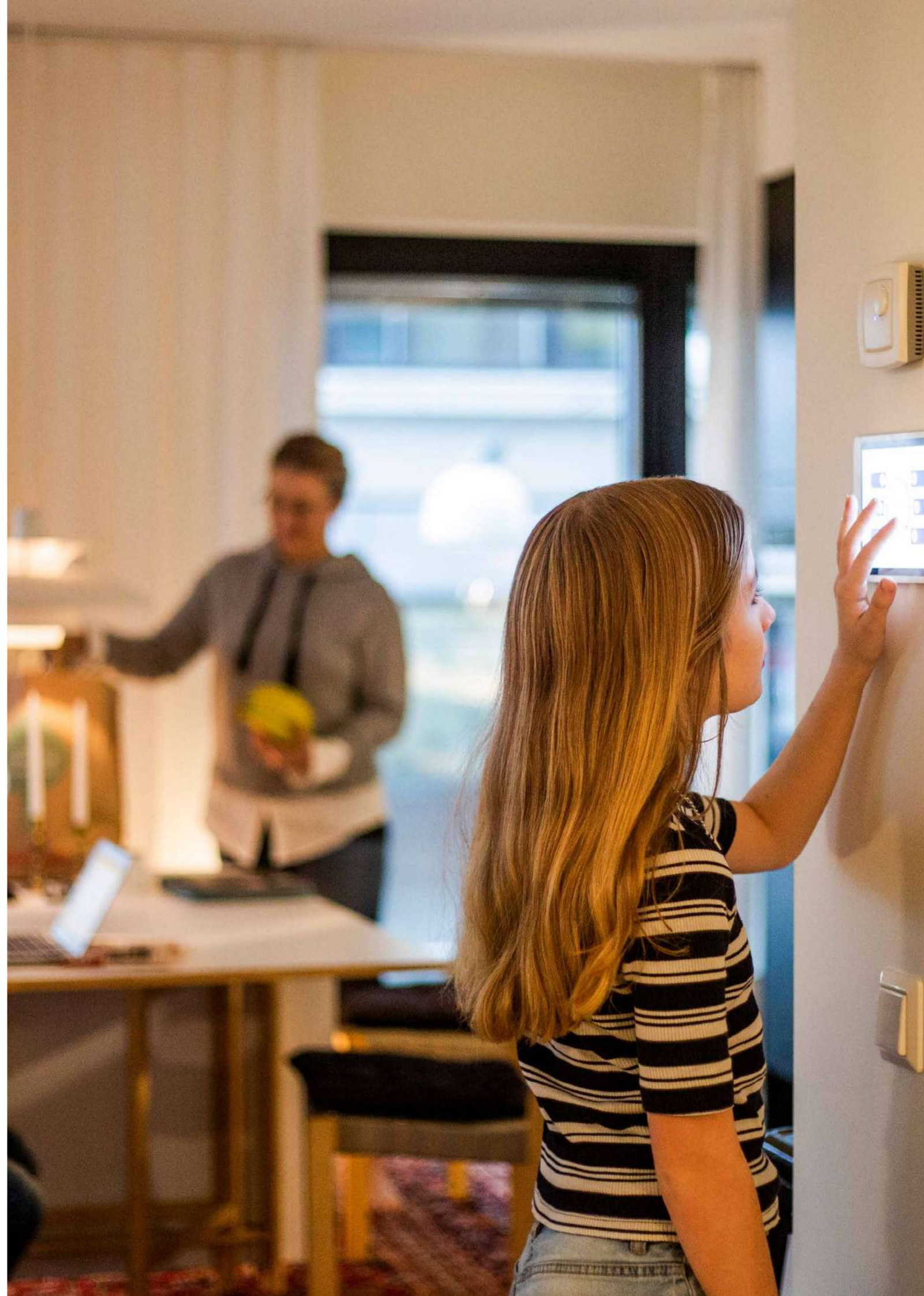



## The benefits of a **smart home**

**Convenience:** remote control and automation of devices make household tasks easier

**Energy saving:** intelligent energy management to reduce unnecessary consumption

**Safety:** real-time monitoring of major household appliances

**Automation:** save time by automating daily tasks

**Accessibility:** easy to use and intuitive app

**Remote management:** control of home functions from your mobile devices

**Customization:** create scenarios and automation to make your living space unique and personal

**Resource management:** monitor energy consumption to reduce waste



## The **4box app**. Customizing your living space

To provide an exceptional level of convenience and control, we have developed a **dedicated app for the S SERIES**: not only does it simplify management, it also makes monitoring and interacting with your devices child's play.

With this app, you can **centralize control of all your 4box S Series products in a single control**. One touch is all it takes to customize your living space.

However, the app's functionality does not stop there. You can manage functions, configure devices, create scenarios and routines, enable voice assistants, and monitor and manage the power consumption of your devices.

**The app you can't live without!**

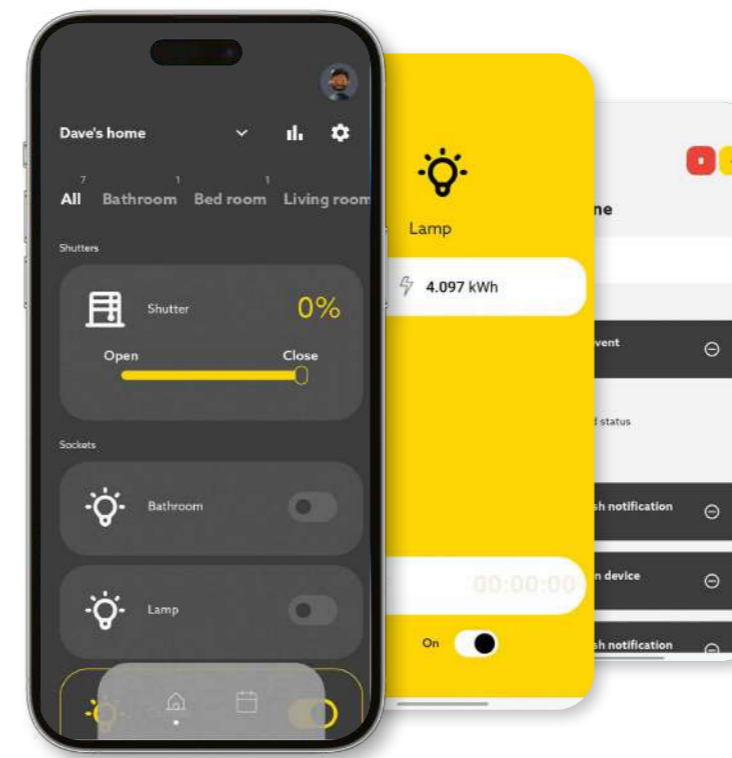







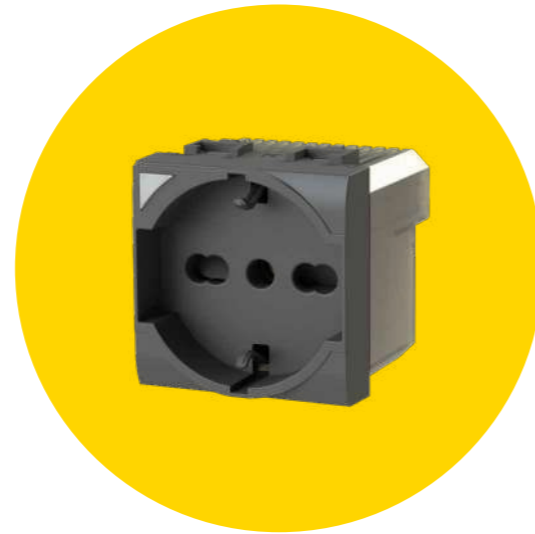

# 4b P40 S

P40 S is the intelligent electrical socket from 4box that revolutionizes your home. Energy consumption is indicated via the built-in LED. It is also fitted with a 16 A relay and can be connected to Wi-Fi without needing a gateway.



## Highlights

-  Built in energy meter
-  Connection via Wi-Fi
-  No need for a gateway
-  Auxiliary terminals IN and OUT to connect external devices
-  Fitted with a 16 A relay
-  Compatible with Google Home and Amazon Alexa

## Total control with a single socket

Monitor your energy consumption in real time with the P40 S built-in energy meter and LED and you always know how much power is being used. The socket is also fitted with a temperature sensor that shuts the power off in case of overheating.

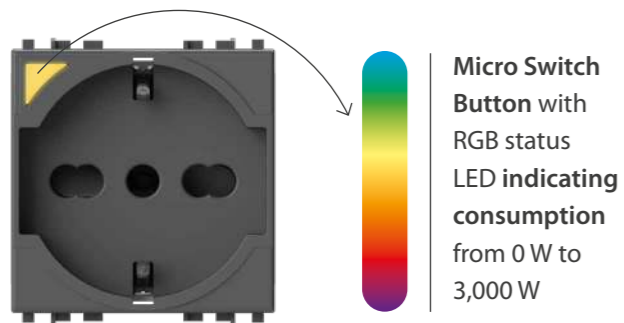

## Intuitive

Monitor your energy consumption in real time with the P40 S. The LED, fitted in the top left hand corner, indicates the current energy consumption with the following simple colour scheme.

-  From 0 W to 100 W the LED turns blue
-  From 100 W to 200 W the LED turns green
-  From 200 W to 400 W the LED turns yellow
-  From 400 W to 1000 W the LED turns orange
-  From 1,000 W to 2,500 W the LED turns red
-  From 2,500 W to 3,000 W the LED turns purple

## Compatible with the most popular residential and commercial wiring accessory systems

Bticino®  
Matix™, LivingLight™, LivingNow™

Vimar®  
Plana™, Arkè™



## P40 S. Packed with power and technology

4box transforms the classic P40 electrical outlet into a technology powerhouse with smart functions. The P40 S (Schuko + 10/16 A) is equipped with a multifunctional **Micro Switch Button** with RGB LEDs, that together with the **Integrated Energy Meter**, instantly measures consumption. The Wi-Fi antenna allows the P40 S to be connected easily to all compatible devices.

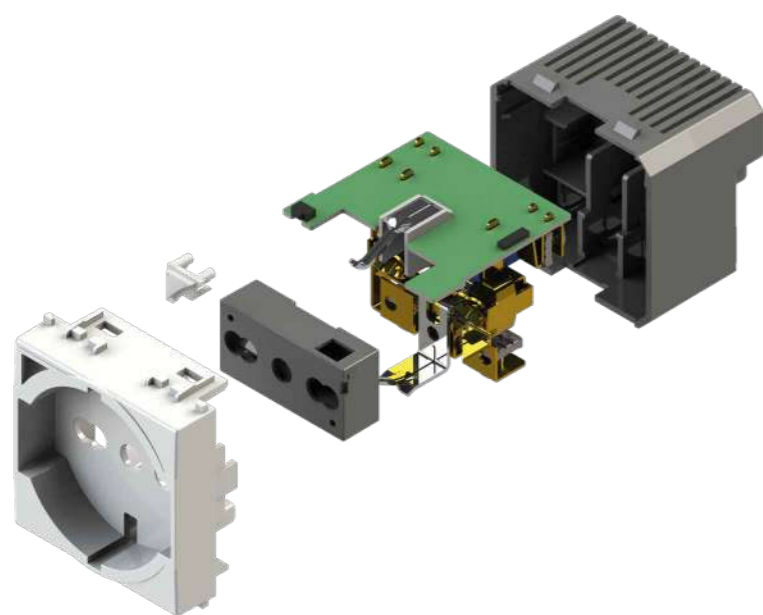

### Connection diagram

Rear 'IN' terminal for connecting 12 switches or push-buttons to control the relay on the P40 Smart. Rear 'OUT' terminal for routing the phase line to another non-Smart socket, so that the latter can be controlled in parallel with the P40 S. Phase, neutral and earth terminals for connection to N mains power supply.

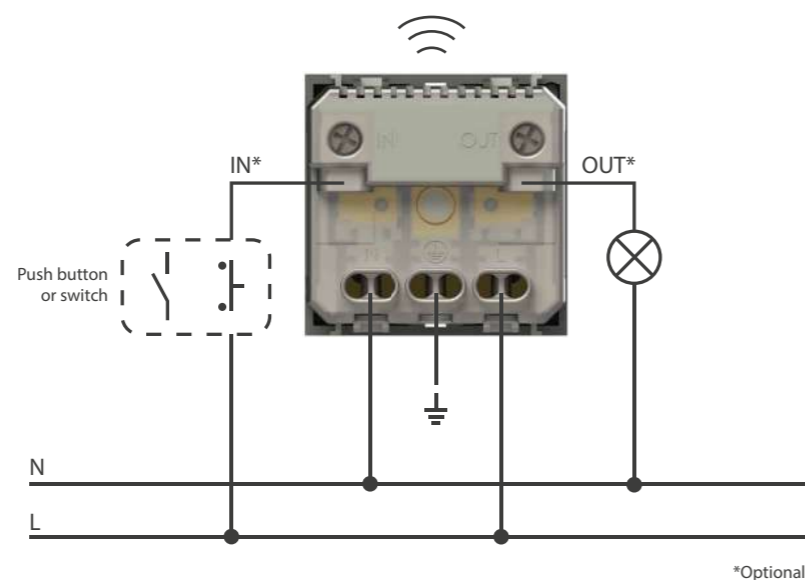

## Catalogue

### P40 S – compatible with Bticino®



4BP40S.AM  
P40 S for  
Matix™  
White



4BP40S.N  
P40 S for  
LivingLight™  
White



4BP40S.L  
P40 S for  
LivingLight™  
Anthracite



4BP40S.NT  
P40 S for  
LivingLight™  
Tech



4BP40S.KW  
P40 S for  
LivingNow™  
White



4BP40S.KG  
P40 S for  
LivingNow™  
Anthracite



4BP40S.KM  
P40 S for  
LivingNow™  
Sand

### P40 S – compatible with Vimar®



4BP40S.V14  
P40 S for  
Plana™  
White



4BP40S.V19B  
P40 S for  
Arkè™  
White



4BP40S.V19  
P40 S for  
Arkè™  
Grey



4BP40S.V19M  
P40 S for  
Arkè™  
Metal

### Plug compatible with P40 S

#### Italian standard

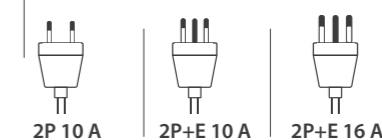

#### German standard

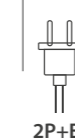

# 4b Uniko Lite S

Uniko has evolved with its new Lite S version: one switch, more possibilities. Uniko Lite S lets you start scenarios, set routines via the app, or control the load. There is a LED on the front that lights up according to its use. Uniko Lite S. Now better than ever!



## Highlights

- Allows you to control 1 light point
- Connection via Wi-Fi
- No need for a gateway
- Status RGB LED
- Compatible with Google Home and Amazon Alexa

## A single switch that gives you total control

The app allows real time display of energy consumption. The internal 7 A relay enables smart control of the connected light.

## More flexible

Depending on the configuration, Uniko Lite S can be installed as a one-way switch, two-way switch, intermediate switch or as a push-button (NO/NC). It can also be used to start a scenario.

## Compatible with the most popular residential and commercial wiring accessory systems

Bticino®  
Matix™, LivingLight™, LivingNow™

Vimar®  
Plana™, Arkè™

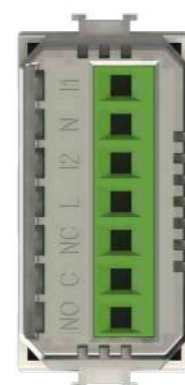



## Uniko Lite S. Simple but special

The basic functions of the Uniko Lite S include **bistable control** (allowing the product to be used as a one-way switch, two-way switch or intermediate switch) and **monostable control** (NO/NC push-button function). In addition, Uniko Lite S lets you manage lighting scenarios, so that you can create the right atmosphere with a simple voice command.

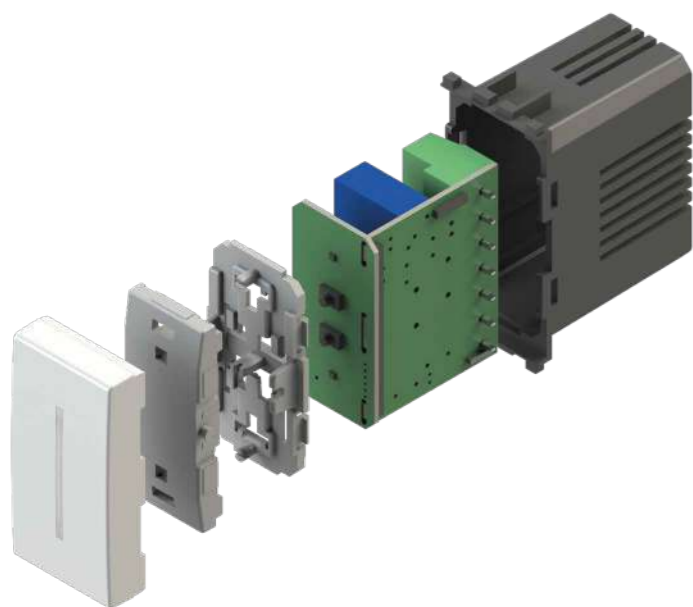

### Connection diagram

- Terminals I1 and I2 for optional push-button inputs
- Neutral N terminal
- Terminals L phase in
- NC and NO terminals for connecting normally open or normally closed contacts
- Terminal C load connection

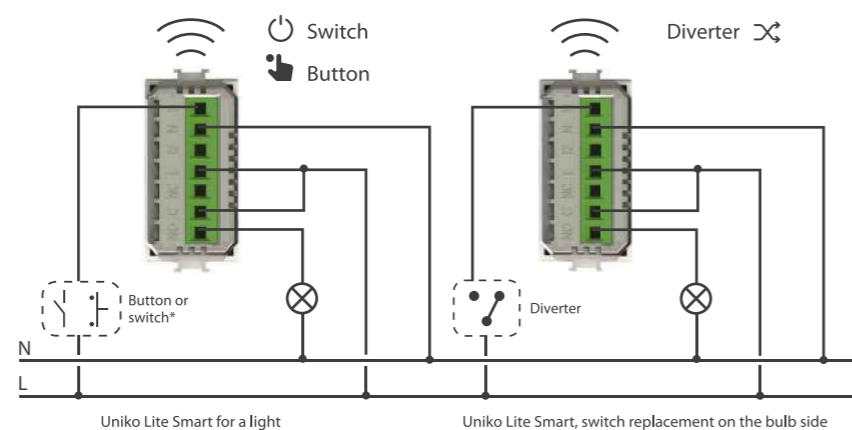

\* In the input it can be connected indiscriminately to Phase (L) or to Neutral (N)  
 ⏻ Switch: set it as default in case no input commands are present  
 🖱️ Button: the command from the app closes the contact for one second

## Catalogue

### Uniko – compatible with Bticino®



**4BCU1S.AM**  
Uniko Lite S for  
**Matix™**  
White



**4BCU1S.N**  
Uniko Lite S for  
**LivingLight™**  
White



**4BCU1S.L**  
Uniko Lite S for  
**LivingLight™**  
Anthracite



**4BCU1S.NT**  
Uniko Lite S for  
**LivingLight™**  
Tech



**4BCU1S.K**  
Uniko Lite S for  
**LivingNow™**  
to be completed with  
Bticino® cover

### Uniko Lite S – compatible with Vimar®



**4BCU1S.V14**  
Uniko Lite S for  
**Plana™**  
White



**4BCU1S.V19B**  
Uniko Lite S for  
**Arkè™**  
White



**4BCU1S.V19**  
Uniko Lite S for  
**Arkè™**  
Grey



**4BCU1S.V19M**  
Uniko Lite S for  
**Arkè™**  
Metal

### Uniko Lite S applications

- One-way switch*
- Two-way switch*
- Intermediate switch*
- Push-button (NO/NC)*

# 4b Uniko Pro S

Uniko Pro S is the multi-functional device brought to you by 4box. In addition to the functions already available in the Lite version, it lets you control two lighting points. With its two built-in relays, it can control the motors of shutters, roller blinds and awnings, and can be operated automatically, even when you are not at home.



## Highlights

- Lets you to control 2 lighting points or 1 roller shutter
- Connection via Wi-Fi
- No need for a gateway
- Compatible with Google Home and Amazon Alexa
- RGB LED
- Built-in energy meter

## Almost everything you need in one device

Multiple functions in a single switch – this is the strength of Uniko Pro S. It has two built-in status LEDs and two (2x 5 A) relays to control 2 lighting points or a roller shutter. The Wi-Fi antenna lets you use these features locally and through app and voice assistants. What's more, the Uniko Pro S lets you monitor energy consumption via the app in real time.

## Intuitive

Uniko Pro S is a multifunctional switch. Other non-smart commands can be connected to terminals 'IN1' and 'IN2'. The terminals 'NO1' and 'NO2' are used to connect output lines with a separate neutral. The phase-neutral terminals allow connection to the mains power supply.

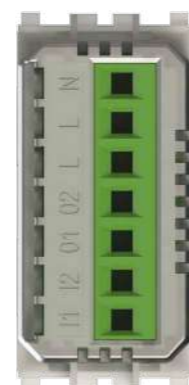

## Compatible with the most popular residential and commercial wiring accessory systems

Bticino®  
Matix™, LivingLight™, LivingNow™

Vimar®  
Plana™, Arkè™



## Uniko Pro S. Almost magical!

The basic functions of the Uniko Pro S include **bistable control** (allowing the product to be used as a one-way switch, two-way switch or intermediate switch) and **monostable control** (push-button function).

In both cases, it can control 2 lights or the motor of roller shutters or curtains.

In addition, Uniko Pro S lets you manage lighting scenarios so you can create the right atmosphere, that you can also do using voice commands.

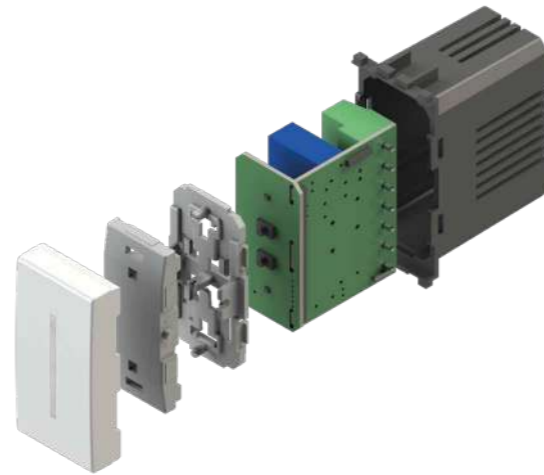

## Catalogue

### Uniko Pro S – compatible with Bticino®



4BCU2S.AM  
Uniko Pro S for  
Matix™  
White

### Uniko Pro S – compatible with Vimar®



4BCU2S.V14  
Uniko Pro S for  
Plana™  
White



4BCU2S.N  
Uniko Pro S for  
LivingLight™  
White



4BCU2S.L  
Uniko Pro S for  
LivingLight™  
Anthracite



4BCU2S.NT  
Uniko Pro S for  
LivingLight™  
Tech



4BCU2S.V19B  
Uniko Pro S for  
Arke™  
White



4BCU2S.V19  
Uniko Pro S for  
Arke™  
Grey



4BCU2S.V19M  
Uniko Lite S for  
Arke™  
Metal



4BCU2S.K  
Uniko Pro S for  
LivingNow™  
to be completed with  
Bticino® cover

### Uniko Pro S applications

- One-way switch
- Two-way switch
- Intermediate switch
- Push-button (NO/NC)
- Roller shutter control

## Connection diagram

- Terminals I1 and I2 for optional push-button inputs
- Terminals O1 and O2, return the device phase for load connection
- Phase terminals L (not to be used to derive other network loads)
- Neutral N terminal

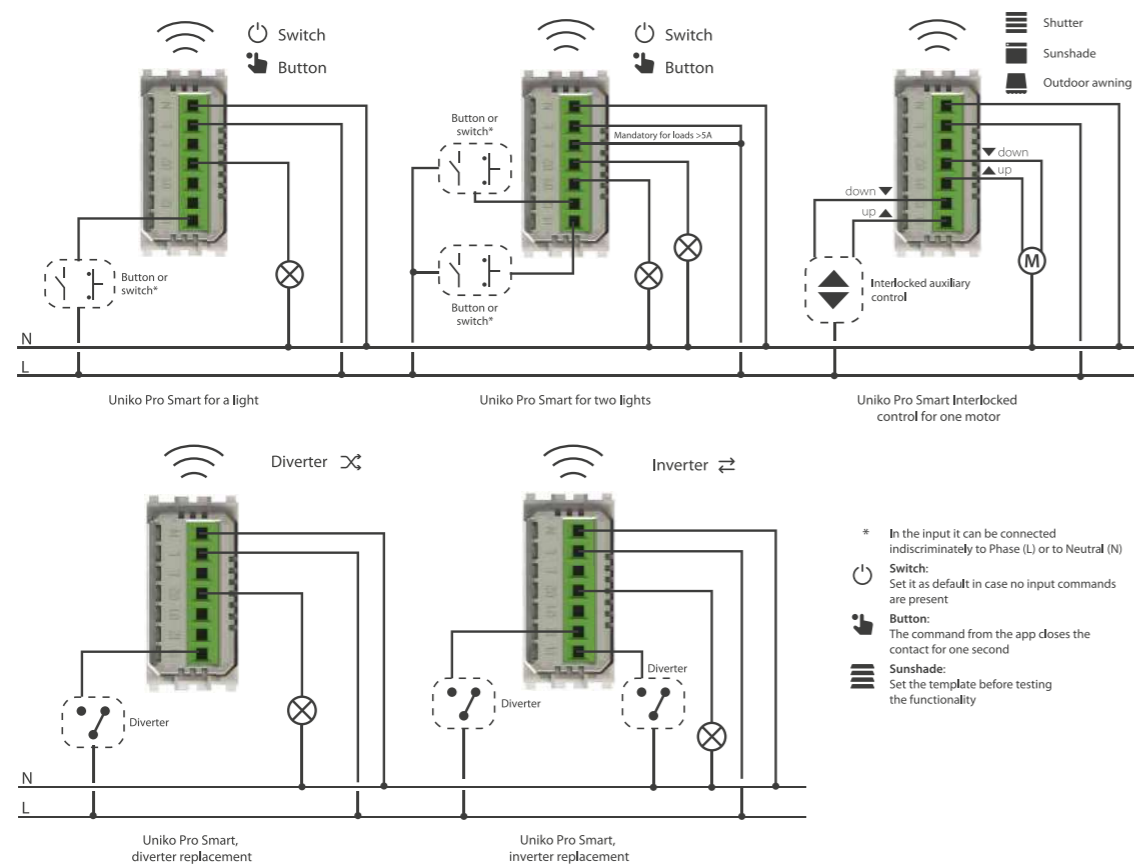



# 4b Relay Lite S | Pro S

Relay Lite S and Relay Pro S are the epitome of compatibility! From now on, it doesn't matter which wiring accessory products you use. Thanks to 4box, any installation can become intelligent. Relay Lite S and Relay Pro S – the smart home for everyone.



## Highlights

- Lets you to control **2 lighting points or 1 roller shutter**
- Connection via **Wi-Fi**
- No need for a gateway**
- Compatible with **Google Home and Amazon Alexa**
- Built-in **energy meter**

## Two commands for almost every need

**Relay Lite S** is the intelligent single channel relay actuator that can control a single light point up to 7 A.

**Relay Pro S** is the intelligent dual channel (2x5 A) relay actuator that can control two lighting points or a motor. They can also be controlled via the app as well as monitoring real-time energy consumption.

## Widely compatible

Thanks to 4box, any system can become smart. Relay Lite S and Relay Pro S ensure compatibility regardless of the residential and commercial wiring accessory systems in use. Place the relay in a junction box or behind a blanking plate and make any system smart. Simple, fast and economical.



Relay Lite S

Relay Pro S

## The right atmosphere at the right time

Relay Lite S and Relay Pro S come with a Wi-Fi and Bluetooth antenna, **letting you to enjoy a range of smart interactions.**

Use the app to create your own routines, ask voice assistants to activate a scenario and track all energy consumption in real time directly from your smartphone.

## Always a good awakening

Relay Pro S lets you to **control the motor of roller shutters** or awnings. Set a routine and they will open at the set time in the morning and close automatically in the evening. You can also use voice assistants to open and close them without lifting a finger. Waking up has never been better.

## Catalogue

### Relay Lite S



4BCU1S.DER  
Relay Lite S,  
single channel relay

### Relay Pro S



4BCU2S.DER  
Relay Pro S,  
double channel relay

# Create your own routines

Smart technologies can be used to automate a range of activities and processes in the home to optimize energy consumption and provide greater convenience. **It's not home automation – it's just easier!** Smart homes refer to the Internet of Things (IoT) and includes all products that use Internet connectivity and smartphone apps to offer new functions with traditional everyday objects such as lights, thermostats and shutters.

## Central control

By setting at least one device as a "scenario" it is possible to use it to recall centralized commands with both short or long presses



## Astro and Time Switching

It is possible to set a routine to be triggered by a time or astronomical event. You can also set offsets and days of the week

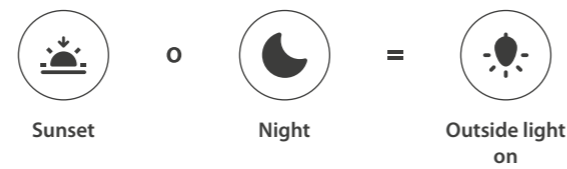

## Loads control

Set a threshold and a time of intervention, then choose the priority order for the devices switching off. A notification will be sent before starting to switch off

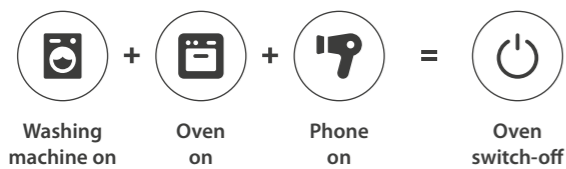

## Weather conditions

The virtual weather station allows you to trigger an automation based on an external weather condition such as rain, wind or temperature



# 4box.it

One site for **all the information you need** – at your **fingertips**

On the 4box.it website, available in the download area, you can find **all the technical data and installation information** regarding the full range of products, and the updated **price lists**.

Enter the world of 4box right now!

Scan the QR code to see the download area

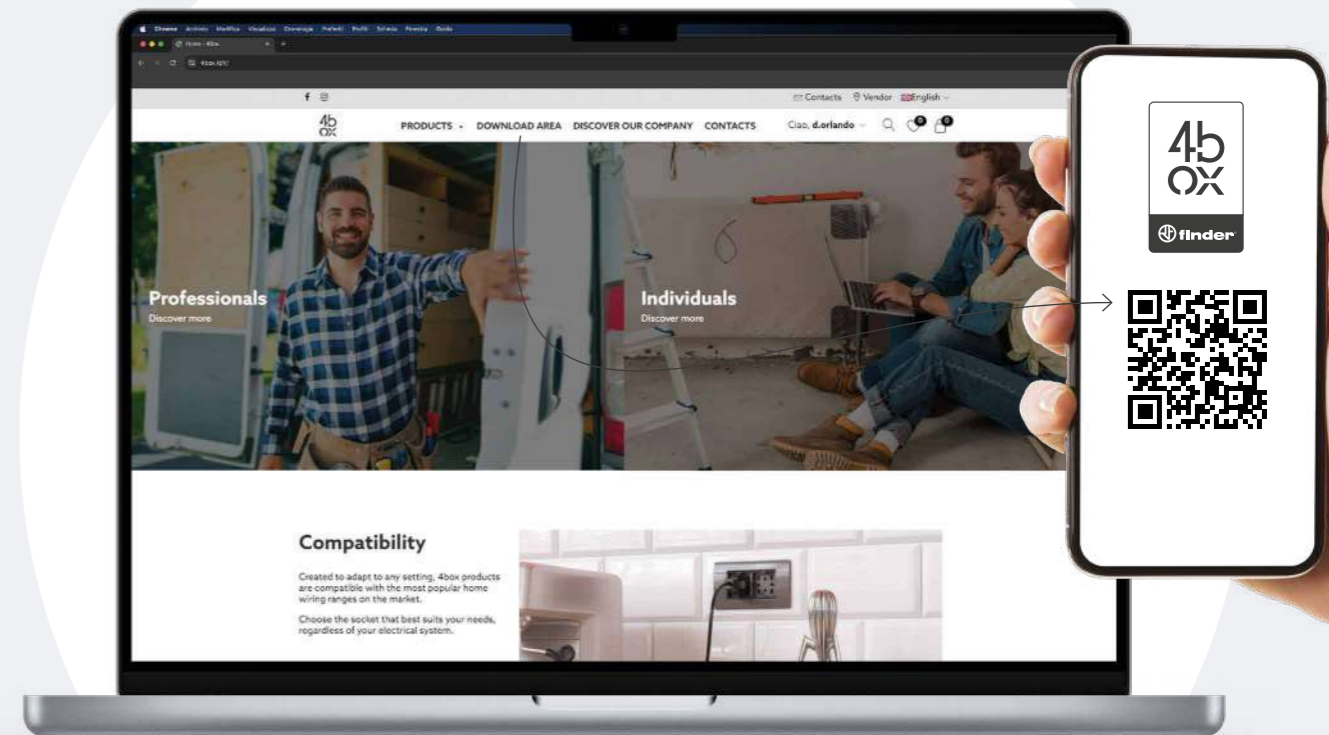



## Copyright

The images in this catalogue are the property of Finder S.p.A., who owns the intellectual property rights and the rights of use and reproduction.

No part of this catalogue may be reproduced without the prior written permission of Finder S.p.A. Trademarks and trade names that appear in this publication are the property of their respective owners. The declared insulation performance was valid at the time of printing. Finder S.p.A. and 4box s.r.l. does not manufacture or market cover plates, frames or modules that are part of other companies' residential and commercial wiring accessory systems.

For the availability of these materials, please contact the respective company's sales network. Trademarks are the property of their respective owners.





2025  
catalogue

Prices, features, specifications, capabilities, appearance and availability of our products and services are subject to change without notice. FINDER assumes no responsibility for the presence of possible errors or insufficient information in this document. In case of discrepancies between the printed and online versions, the latter prevails.

## Follow us on social media

---

[findernet.com](http://findernet.com) | [4box.it](http://4box.it)

Instagram  
[@finderitalia](https://www.instagram.com/finderitalia) | [@4box\\_official](https://www.instagram.com/4box_official)

Facebook  
[@Finder Italia](https://www.facebook.com/finderitalia) | [@4boxsocial](https://www.facebook.com/4boxsocial)

Youtube  
[@FinderItalia](https://www.youtube.com/finderitalia) | [@4Box Official Channel](https://www.youtube.com/4BoxOfficialChannel)

Linkedin  
[@finder-relays](https://www.linkedin.com/company/finder-relays)

X  
[@finderitalia](https://twitter.com/finderitalia)



ZCTENEN4BOX - I/2025 - 4box catalogue